The Great Stoneboro Fair

Welcome to the 156th Edition of The Great Stoneboro Fair.

We wish to extend a big “Thank You” to our Committees, Advertisers,
Sponsors, Exhibitors, and Fairgoers for making our Fair a success.

We hope you will enjoy your visit to the Fair!

Sincerely,

THE GREAT STONEBORO FAIR

Board of Directors

INDEX

Officers, Directors & Superintendents.....	2
Advertising Index.....	3
Schedule of Events.....	4-10
Sponsors.....	16
Ticket Information.....	18
Rules and Regulations.....	19-21
Office Hours.....	21
Advice to Exhibitors / Health Rules & Regulations.....	22-23
PA Department of Ag Health Rules & Requirements.....	156-202

PREMIUM LIST

Department	1 - Horses.....	27
Department	2 - Dairy Cattle.....	34
Department	3 - Beef Cattle.....	37
Department	4 - Sheep & Wool.....	39
Department	6 - Goats.....	43
Department	8 - Poultry-Eggs.....	45
Department	9 - Rabbits.....	53
Department	101 - 4-H & FFA.....	57
Department	11 - Youth.....	66
Department	12 - Grains & Seed Crops.....	72
Department	13 - Vegetables.....	75
Department	14 - Fruits & Nuts.....	78
Department	15 - Food.....	82
Department	17 - Floral Exhibits.....	86
Department	18 - Needlecraft.....	90
Department	19 - Arts & Crafts & Photography.....	95
Department	22 - Special Contests.....	99
Department	23 - Apiary & Maple Products.....	105
Entry Forms.....		203-210
Camping Request Form.....		207

The Great Stoneboro Fair

OFFICERS & DIRECTORS

Shirley McIntire.....President
Marc Saeler.....Vice President
Patty Adamson.....Secretary
Lisa Hicks.....Treasurer
Susan Patterson, Sherry Reynolds. Office Staff

Chris Baer
Derek Beach
Jon Gander
Jodi Martin

Bobby Minor
Jason McCurdy
Jim Uber
Don Jones - Board Member Emeritus

Fair Office Phone: (724)376-2852

AUDITORS

Scott Black Linda Butler John McCullough

COMMITTEES AND SUPERINTENDENTS

Advertising & Publicity.....Patty Adamson, Jason McCurdy
Baked & Canned Goods.....Jane Sefton
Beef Cattle, Sheep, Goats.Eric Ligo, Dave McCullough, Bobby Minor
Buildings & Grounds.....Glenn Jewell, Marc Saeler, Mick Saeler
Chaplain.....Pastor Glenn Walker
Concessions.....Patty Adamson, Jason McCurdy, Chris Baer
Dairy Cattle.Don Jones, Bobby Minor, Kevin Minor, Eric Ligo
Electricians.....Wilson Electric Service
Entertainment.....Marc Saeler, Jenn Saeler
Entry Secretaries.Linda Butler, Lou Ann Iskat, Jana Sharp
Farm Crops.....Denny Geibel, Jon Gander
Fruits and Vegetables.....Dale Anderson
Fine Arts.....Susie Jones, Lisa Scott
First Aid.....Superior Ambulance Service
Gates.....Allan Robinowitz, Bob Foust, Jason McCurdy
Grain & Seed Crops.....Bob Calvert, Denny Geibel, Marc Saeler, Jon Gander
Harness Racing Secretary.....Jodi Martin
Horses and Ponies.....Jim Uber, Kelly Beach
Off-Season Rentals.....Shirley McIntire, Jon Gander
Parking & Security.....Bobby Minor, Derek Beach, Jason McCurdy, Chris Baer
Premium Book Ads.....Office Staff
Poultry.....Tom Schaffer
Rabbits.....Zoe Pizor, Morgan Powers
Souvenirs & Pins.Shirley McIntire, Patty Adamson

ADVERTISING INDEX

A

The Alternative Sales.....	110
Armstrong Cable	109
AWL & L Insurance	123

B

Bell's Sanitation.....	63
Ben Bissett.....	132
Braham Auctioneers.....	126

C

Cadman Fire Extinguisher.....	124
Charles E. Drew Barber Shop.....	98
Clapper Insurance.....	133
Custom Corner Printing.....	140

D

D. Patts Lawn Care.....	121
Dev's Sailor Market	148
Dev's Subway	148

F

Fairview Swiss Cheese.....	154
Flexospan Inc.	141
Fyda Freightliner.....	155

G

GCA.....	150
GingerSnap Junction.....	107
Grantham's Landing	114
Greenfield, Doug & Jeannie	119
Griffin Arms.....	118
Grove City Agway.....	74

H

H & H Materials.....	119
Hicks Auto Service	32
Hillmar Auction Service.....	111
Howard & Son Meat Pkg.....	146

I

Interstate Self Storage.....	128
------------------------------	-----

J

J & J Sauer Parts & Sales.....	108
JB's Retreat.....	108
Jackson Center Vol. Fire Co	134
Jane's Stromboli.....	116
Jacob Weaver Co	137

K

Thomas J. Kosick DMD.....	113
Kress Auto Center	127
Krystyak's Korner.....	149

L

Lakeview Area Library.....	141
Laubscher Cheese Co	142
Lynchwoods Spirits.....	143

M

Maple Lane Farm.....	42
Marburger Farm Dairy.....	(inside front cover)
McCartney's Feed Mill & Hdw	128
McClung Auto Body	111
McDowell Imp. Co.....	120
Meadville Floors.....	131
Mercer Co. Antique Power Assoc.....	100
Mercer Co. State Bank.....	(back cover)
Methodists Circle of Faith.....	153
Michele Brooks - 17 th District	114
Mijavec's Catering.....	151
Minor Acres Packing Co.....	129

N

Newton Financial Services.....	130
NexTier Bank.....	152

P

Palmer Pool Sales.....	32
Patterson Septic Service.....	112
Penn Valley Show, LLC.....	145
Pub 76	98
Plyler Entry Systems.....	136
Pymatuning Fire Ins.....	97

Q

Quillen's Café	115
----------------------	-----

R

R.A.S. Outdoors Inc.....	127
Reddick Roll Offs.....	125
Reiser Automotive	147
Rose and Black Funeral Home	117

S

Saeler Construction.....	125
S. L. Auto Parts.....	(back outside cover)
Sandy Lake Implement.....	144
Sandy Lake Mills.....	107
Spiegel's Floor Coverings	115
C. Sullivan Electric	89

W

Watson's Inc.....	44
Wilson Electric	139
Wimer Fuel Injection	106

Y

Yellow Creek Inn.....	122
-----------------------	-----

Z

Z & B Storage	138
---------------------	-----

The Great Stoneboro Fair

“Always on Labor Day”

“A Family Tradition for 156 Years”

Tuesday, August 27, 2024 Entries For Fine Arts & Rabbits

Wednesday, August 28, 2024 (Entry Day)

Through Monday, September 2, 2024 (Labor Day)

Ticket Information — Pay One Price

Thursday, August 29-Labor Day - \$15.00 (2 years and older)

****PRE-SALE TICKETS****

Pre-Sale Ticket Price \$12.00

Pre-Sale tickets available through Wednesday, August 28, 2024

You can buy tickets online until Midnight!

Admission Includes the Following:

Parking

Grandstand Seating for All Shows and Harness Races

Seats are on a “first come basis” – No Reserved Seating –

No admittance to Grandstand until 1 1/2 hours before event – NO EXCEPTIONS

Midway Rides-Thursday-5:00 PM -11:00 PM //

Friday-5:00 PM-11:00 PM // Saturday-1:00 PM-11:00 PM //

Sunday-1:00 PM-11:00 PM// Monday-Noon-9:00 PM

****INDIVIDUALS MUST MEET MINIMUM HEIGHT REQUIREMENTS AS REQUIRED BY LAW TO BE ABLE TO RIDE MECHANICAL RIDES – NO EXCEPTIONS.****

SPIKER HELICOPTER RIDES AND PIT PASSES ARE NOT INCLUDED IN THE PRICE OF ADMISSION.

ATTENTION PARENTS AND GUARDIANS: Children under 2 years of age are admitted FREE to the Fair. This is gate admission only and does not include rides. All riders, including children of all ages, must have a ride wristband. You may purchase the ride wristband at any gate. The only exception is the Merry-Go-Round where kids under 2 years old can ride without a ride wristband if accompanied by one adult who does have a ride wristband.

****INDIVIDUALS MUST MEET MINIMUM HEIGHT REQUIREMENTS AS REQUIRED BY LAW TO BE ABLE TO RIDE MECHANICAL RIDES – NO EXCEPTIONS.****

****Rabbit Exhibits and Fine Arts Building Entries must be in place by 8:00 PM on Tuesday, August 27, 2024.**

*****Pony Ride Rules – Please keep in mind that during this time ponies will be taking two much needed one-hour breaks. Those times will be determined depending upon coinciding entertainment. Please be patient during these times as this is essential for the safety, comfort, and health of the ponies.*****

WEDNESDAY, AUGUST 28

ENTRY DAY

Office Hours 10 AM – 10PM

9 AM-9 PM

ENTRY OFFICE

*All Exhibits must be registered by Aug. 07, 2024
All Exhibits must be in place by 9:00 PM on
Wednesday, Aug 28, (except Rabbits & Fine Arts).
Fine Arts & Rabbits must be in place by 8 PM on
Tuesday, Aug. 27.*

8:00 AM - Noon

JUDGING: Fine Arts Building

10:00 AM

RABBIT SHOW (*On hill by Wildlife Building*)

4:00 PM

VENDORS OPEN

4:00 PM - 9 PM

Buffalo Beal’s Animal Park—*Petting Zoo, Pony Rides*(*Centerfield*)

4:00 PM - 10PM

Hay Maze Open (*Centerfield*)

5:00 PM - 9 PM

Magic Man TJ Hill (*Strolling&Centerfield Stage @ 6:30*)

6:00 PM - 10 PM

Rides in Operation (*Midway*)

Ride preview special \$10.00

*** Individuals must meet minimum height requirements
as required by law to be able to ride mechanical
rides – no exceptions.***

6:30 PM

Magic Man TJ Hill (*Centerfield Stage*)

7:00 PM

FAIR OPENING (*Milking Parlor*)

7:00 PM

Milking Contest (*Milking Parlor*)

FREE Dairy Products Sponsored by

Mercer County Dairy Promotion Committee

7:00 PM

Allegheny Highland Pulling Assoc. Garden Tractor Pulls
(*Centerfield*)

7:00 PM

Brunon Blaszak’s Royal Bengal Tigers Show (*Centerfield*)

7:30 PM

Rennels Rustic Chainsaw Carving (*Centerfield*)

FOAM AND FUN

TBD

Entries Close

Wednesday, August 7, 2024

**DUE TO LIMITED SPACE MAKE YOUR
ENTRIES EARLY!**

THURSDAY, AUGUST 29

Office Hours 10 AM – 11PM

8:00 AM	JUDGING: Foods, Fine Arts, Crops, and Wool
4:00 PM	VENDORS OPEN
4:00 PM- 9 PM	Ryan Gothrup Blacksmith Demonstration (<i>Centerfield</i>)
4:00 PM- 9 PM	Buffalo Beal's Animal Park— <i>Petting Zoo, Pony Rides</i> (<i>Centerfield</i>)
4:00 PM - 10PM	Hay Maze Open (<i>Centerfield</i>)
4:30 PM	Axe Women Loggers of Maine (<i>Centerfield</i>)
5:00 PM	Harness Racing
5:00 PM - 11 PM	Rides in Operation (<i>Midway</i>)
	<i>** Individuals must meet minimum height requirements as required by law to be able to ride mechanical rides – no exceptions.**</i>
5:00 PM	Rannels Rustics Chainsaw Carving (<i>Centerfield</i>)
5:00 PM - 9 PM	Magic Man TJ Hill (<i>Strolling&Centerfield Stage @ 6:30</i>)
5:00 PM	Rock N Circus (<i>Centerfield</i>)
5:30 PM	Brunon Blaszak's Royal Bengal Tigers Show (<i>Centerfield</i>)
6:00 PM	Axe Women Loggers of Maine (<i>Centerfield</i>)
6:00 PM	Baked Goods Auction (<i>Ibbs Building</i>)
	Auctioneer: Don Braham
6:00 PM	JUDGING: Goats (<i>Mohney Arena</i>)
6:00 PM	Equine Costume Contest (<i>Alex Sharp Horse Ring</i>)
6:30 PM	Agri-Puppets Show (<i>Centerfield</i>)
6:30 PM	Magic Man TJ Hill (<i>Centerfield Stage</i>)
7:00 PM	Rannels Rustics Chainsaw Carving (<i>Centerfield</i>)
7:00 PM - 9PM	TBD (<i>Bedford Grange Mutual Insurance Pavilion, Centerfield</i>)
7:30PM	Rock N Circus (<i>Centerfield</i>)
7:30 PM	Axe Women Loggers of Maine (<i>Centerfield</i>)
8:00 PM	Brunon Blaszak's Royal Bengal Tigers Show (<i>Centerfield</i>)
8:00 PM	Agri-Puppets Show (<i>Centerfield</i>)



HARNES RACES

Thursday, August 29 — 5:00 PM

Friday, August 30 — Noon

FRIDAY, AUGUST 30

Office Hours 10 AM – 11PM

8:30 AM	Dairy Cattle Judging (<i>Mohney Arena</i>) Followed by Dairy Showmanship Classes
10:00 AM	Miniature Equine and Pony Show (<i>Alex Sharp Horse Ring</i>)
NOON	Harness Racing
11:00 AM	VENDORS OPEN
4:00 PM - 9 PM	Ryan Gothrup Blacksmithing Demonstration (<i>Centerfield</i>)
4:00 PM - 9 PM	Buffalo Beal's Animal Park—Petting Zoo, Pony Rides (<i>Centerfield</i>)
4:00 PM - 10PM	Hay Maze Open (<i>Centerfield</i>)
4:30 PM	Rannels Rustics Chainsaw Carving (<i>Centerfield</i>)
5:00 PM - 9 PM	Magic Man TJ Hill (<i>Strolling&Centerfield Stage @ 6:30</i>)
5:00 PM - 9 PM	Miniature Equine and Pony Fun Show (<i>Alex Sharp Horse Ring</i>)
5:00 PM - 11 PM	Rides in Operation (<i>Midway</i>)
5:00 PM	Brunon Blaszak's Royal Bengal Tigers Show (<i>Centerfield</i>)
5:30PM	Rock N Circus (<i>Centerfield</i>)
6:00 PM	Axe Women Loggers of Maine (<i>Centerfield</i>)
6:00 PM	Antique Tractor Pull, Weigh-In 5PM (<i>Centerfield – Exhibitors Only</i>)
6:30 PM	Agri-Puppets Show (<i>Centerfield</i>)
6:30 PM	Magic Man TJ Hill (<i>Centerfield Stage</i>)
7:00 PM	Bull Ride Mania Rodeo (<i>Grandstand</i>) Grandstand Opens at 5:30pm – NO RESERVED SEATING
7:00 PM	Rannels Rustics Chainsaw Carving (<i>Centerfield</i>)
7:00 PM - 9PM	TBD (<i>Bedford Grange Mutual Insurance Pavilion, Centerfield</i>)
7:30PM	Rock N Circus (<i>Centerfield</i>)
7:30PM	Axe Women Loggers of Maine (<i>Centerfield</i>)
8:00 PM	Brunon Blaszak's Royal Bengal Tigers Show (<i>Centerfield</i>)
8:00 PM	Agri-Puppets Show (<i>Centerfield</i>)

SATURDAY, AUGUST 31

Office Hours 10 AM – 11PM

10:00 AM	JUDGING: Open Beef, Sheep (<i>Mohney Arena</i>)
11:00 AM	Antique Tractor Pull (<i>Centerfield</i>), Weigh-in 10:00 AM
11:00 AM	VENDORS OPEN
Noon – 10PM	Hay Maze Open (<i>Centerfield</i>)
Noon - Dusk	Spiker Helicopter Rides (<i>Sign Up in Centerfield</i>)
Noon - 2 PM	TBD (<i>Bedford Grange Mutual Insurance Pavilion, Centerfield</i>)
1:00 PM - 11 PM	Rides in Operation (<i>Midway</i>) ** Individuals must meet minimum height requirements as required by law to be able to ride mechanical rides – no exceptions.**
1:30 PM	Rannels Rustics Chainsaw Carving (<i>Centerfield</i>)
2:00 PM – 9PM	Buffalo Beal’s Animal Park– <i>Petting Zoo, Pony Rides</i> (<i>Centerfield</i>)
2:00 PM - 8 PM	Ryan Gothrup Blacksmithing Demonstration (<i>Centerfield</i>)
2:00 PM - 9 PM	Magic Man TJ Hill (<i>Strolling & Centerfield Stage @ 6:30</i>)
2:30 PM	Agri-Puppets Show (<i>Centerfield</i>)
3:00 PM	Axe Women Loggers of Maine (<i>Centerfield</i>)
3:30 PM	Rock N Circus (<i>Centerfield</i>)
4:00 PM	Rannels Rustics Chainsaw Carving (<i>Centerfield</i>)
4:30 PM	Agri-Puppets Show (<i>Centerfield</i>)
4:00 PM - 6 PM	TBD (<i>Bedford Grange Mutual Insurance Pavilion, Centerfield</i>)
5:00 PM	Draft Horse & Haflinger Horse Show Followed by the Hitch & Obstacle Classes (<i>Alex Sharp Horse Arena</i>)
5:00 PM	Brunon Blaszak’s Royal Bengal Tigers Show (<i>Centerfield</i>)
5:00 PM	Axe Women Loggers of Maine (<i>Centerfield</i>)
6:00 PM	Rock N Circus (<i>Centerfield</i>)
6:30 PM	Rannels Rustics Chainsaw Carving (<i>Centerfield</i>)
7:00 PM	DEMOLITION DERBY -HARD CORE DERBY PROMOTIONS / Grandstand opens at 5:30 PM, No Reserved Seating
7:00 PM	Axe Women Loggers of Maine (<i>Centerfield</i>)
7:00 PM	Agri-Puppets Show (<i>Centerfield</i>)
7:30 PM	Brunon Blaszak’s Royal Bengal Tigers Show (<i>Centerfield</i>)
7:30 PM	TBD (<i>Bedford Grange Mutual Insurance Pavilion, Centerfield</i>)
8:00 PM	Rock N Circus (<i>Centerfield</i>)

The Great Stoneboro Fair

SUNDAY, SEPTEMBER 1

9:00 AM	Light Horse Halter Classes & Light Horse and Pony Show (<i>Alex Sharp Horse Ring</i>)
11:00 AM	Fair Church Service (<i>Mohney Arena</i>)
11:00 AM	VENDORS OPEN
Noon-10PM	Hay Maze open (<i>Centerfield</i>)
1:00 PM- 11PM	Rides in Operation (<i>Midway</i>)
1:30 PM	Rannels Rustics Chainsaw Carving (<i>Centerfield</i>)
2:00 PM - 4 PM	TBD (<i>Bedford Grange Mutual Insurance Pavilion, Centerfield</i>)
2:00 PM - 4 PM	Buffalo Beal's Animal Park-Petting Zoo, Pony Rides (<i>Centerfield</i>)
2:00 PM - 9 PM	Magic Man TJ Hill (<i>Strolling&Centerfield Stage @ 6:30</i>)
2:00 PM - 8 PM	Ryan Gothrup Blacksmith Demonstration (<i>Centerfield</i>)
2:00 PM	Dairy Promotion Activity (<i>Mohney Arena</i>)
	Free Ice Cream Sundae Sponsored by Mercer County Dairy Promotion Committee
2:00 PM	Brunon Blaszak's Royal Bengal Tigers Show (<i>Centerfield</i>)
2:30 PM	Agri-Puppets Show (<i>Centerfield</i>)
3:00 PM	Axe Women Loggers of Maine (<i>Centerfield</i>)
3:30 PM	Rock N Circus (<i>Centerfield</i>)
4:00 PM – 6 PM	Ron Knapp: Bluegrass, Country & Gospel (<i>Fine Arts Building</i>)
5:00 PM	Light Horse Fun Show (<i>Alex Sharp Horse Arena</i>)
4:00 PM	Rannels Rustics Chainsaw Carving (<i>Centerfield</i>)
4:30 PM	Agri-Puppets Show (<i>Centerfield</i>)
5:00 PM	Brunon Blaszak's Royal Bengal Tigers Show (<i>Centerfield</i>)
5:00 PM	Axe Women Loggers of Maine (<i>Centerfield</i>)
6:00 PM	Rock N Circus (<i>Centerfield</i>)
6:00 PM - 8 PM	TBD (<i>Bedford Grange Mutual Insurance Pavilion, Centerfield</i>)
6:30 PM	Rannels Rustics Chainsaw Carving (<i>Centerfield</i>)
6:30 PM	Magic Man TJ Hill (<i>Centerfield Stage</i>)
7:00 PM	DEMOLITION DERBY -HARD CORE DERBY PROMOTIONS Grandstand opens at 5:30pm, No Reserved Seating
7:00 PM	Axe Women Loggers of Maine (<i>Centerfield</i>)
7:00 PM	Agri-Puppets Show (<i>Centerfield</i>)
7:30 PM	Brunon Blaszak's Royal Bengal Tigers Show (<i>Centerfield</i>)
8:00 PM	Rock N Circus (<i>Centerfield</i>)
10:30 PM	Fireworks by Griffin Arms, Sponsored by Wilson Electric and Heckman Diversified
FOAM AND FUN	TBD

MONDAY, SEPTEMBER 2

Office Hours 10 AM – 11PM

9:30 AM	VENDORS OPEN
Noon - 9 PM	Hay Maze open (<i>Centerfield</i>)
Noon - 9 PM	Rides in Operation (<i>Midway</i>)
Noon - Dusk	Spiker Helicopter Rides (<i>Sign up in Centerfield</i>)
Noon - 6 PM	Ryan Gothrup Blacksmith Demonstration (<i>Centerfield</i>)
Noon - 7 PM	Buffalo Beal's Animal Park - Petting Zoo, Pony Rides (<i>Centerfield</i>)
12:30 PM - 2:30 PM	TBD (<i>Bedford Grange Mutual Insurance Pavilion, Centerfield</i>)
2:00 PM - 7 PM	Magic Man TJ Hill (<i>Strolling and Centerfield Stage @ 6:30</i>)
1:00 PM	Rannels Rustics Chainsaw Carving (<i>Centerfield</i>)
1:30 PM	Brunon Blaszak's Royal Bengal Tigers Show (<i>Centerfield</i>)
2:00 PM	Agri-Puppets Show (<i>Centerfield</i>)
2:30 PM	Axe Women Loggers of Maine (<i>Centerfield</i>)
3:00 PM	Rock N Circus (<i>Centerfield</i>)
3:30 PM - 5:30 PM	TBD (<i>Bedford Grange Mutual Insurance Pavilion, Centerfield</i>)
3:30 PM	Rannels Rustics Chainsaw Carving (<i>Centerfield</i>)
4:00 PM	Agri-Puppets Show (<i>Centerfield</i>)
4:30 PM	Brunon Blaszak's Royal Bengal Tigers Show (<i>Centerfield</i>)
4:30 PM	Axe Women Loggers of Maine (<i>Centerfield</i>)
5:00 PM	Truck & Tractor Pull (<i>Grandstand</i>) Northwest Pullers
5:30 PM	Rock N Circus (<i>Centerfield</i>)
6:00 PM	Rannels Rustics Chainsaw Carving (<i>Centerfield</i>)
6:30 PM	Axe Women Loggers of Maine (<i>Centerfield</i>)
6:30 PM	Magic Man TJ Hill (<i>Centerfield Stage</i>)
7:00 PM	Agri-Puppets Show (<i>Centerfield</i>)
7:00 PM	Brunon Blaszak's Royal Bengal Tigers Show (<i>Centerfield</i>)
7:30 PM	Rock N Circus (<i>Centerfield</i>)
7:30 PM	The Great Stoneboro Fair Benefit Auction Wood Carvings and Blacksmith pieces (<i>Bedford Grange Mutual Insurance Pavilion, Centerfield</i>) <i>proceeds to benefit The Great Stoneboro Fair</i>
FOAM AND FUN	TBD



Friday
August 30th - 7:00 PM
Grandstand

Sponsored By





DEMOLITION DERBY

Thank you PA Lottery for Sponsoring the Demolition Derby!

Saturday, August 31, 2024

7:00 pm

Sunday, September 1, 2024

7:00 pm

Fireworks



Sunday, September 1st – 10PM

Fireworks by Griffin Arms

Sponsored By
Wilson Electric &
Heckman
Diversified

Spiker

Helicopters

Saturday, August 31, 2024 - Noon to Dusk
Monday, September 2, 2024 – Noon to Dusk

Weather Permitting

Helicopter rides are not included in the
price of gate admission.

Northwest PA Truck & Tractor Pullers Assoc.



**Thank you Pruskowski Trucking and Monroe
Tractors for Sponsoring!**

**Truck and Tractor Pull
Labor
Day
5:00 PM**

2024 GREAT STONEBORO FAIR SPONSORS

*Thank you to all our sponsors!
See page 135 for more info*

FRIENDS OF THE FAIR

Clapper Insurance
McCartney Feed & Hardware
Jacob A Weaver Co.
Maple Lane Farms
Michele Brooks, State Senator
Reiser Automotive
Walter Edwards
Kenneth Butala

Sandy Lake Auto Parts
Shirley McIntire
Vaughn Chiropractic
Wilson Electric
Mercer Auto Wreckers, LLC.
Shannon's Kandy Kitchen
Pruskowski Trucking
Larry Pears

Flexospan (In Memory of Bruce A. McQuiston)
Sherry Reynolds & Duane Mohney in Memory of D. Lee Mohney

SPECIAL THANK YOU TO THE FOLLOWING

Braham Auctions
Friends of the Fair Golf Cart Team
Pastor Glenn Walker
Jack Philson Family
Book Family Seed Sales
Lakeview Fertilizer

Mercer County Dairy
Promotion Committee
Mercer County Holstein Club
Shirley McIntire

**SPECIAL THANKS
To ALL Volunteers and the
New Stoneboro Junior Fair Board**



Check Out
The Great Stoneboro Fair
Souvenirs
NEW THIS YEAR!!
Our 2024 Collector Fair Pin



**Check out our selection
of Souvenirs and Apparel!**

Ticket Information

PAY ONE PRICE

\$15

Thursday –
Labor Day

Gate Admission Fee

includes:

PARKING
GRANDSTAND SEAT
MIDWAY RIDES
CENTERFIELD SHOWS

2 yrs and older

Free Gate Admission Wednesday

Midway Ride Hours

Thursday	5:00pm - 11:00pm
Friday	5:00pm - 11:00pm
Saturday & Sunday	1:00pm - 11:00pm
Monday (Labor Day)	Noon - 9:00pm

Individuals must meet minimum height requirements as required by law to be able to ride mechanical rides - **NO EXCEPTIONS!**

Pre-Sale Tickets on Sale!

Stop by the Secretary's Office any Wednesday to get your Pre-Sale Tickets available through Aug.28, until 10:00 PM includes Midway and All Shows

\$12 per day Pre-Sale

Secretary's Office: (724)376-2852

GENERAL & LIVESTOCK RULES & REGULATIONS

1. All Exhibitors agree to be bound by the rules and regulations of the Stoneboro Fair.
2. The Fair Management reserves the right to amend or add to these rules & regulations as its judgment may determine.
3. Reasonable care will be taken to protect all exhibits on display from all injury and damage but the Fair is not, in any way, to be held responsible for accidents, loss or damage by water, fire, theft or otherwise, whatever may be the cause or extent of the damage or loss.
4. Entries will be made according to classification.
5. Premiums, as listed, may be given for meritorious exhibits. In cases where there is no competition, judges may give an award such as they deem the exhibit is worthy to receive. The same rule applies where there are fewer entries in any class than the number of premiums offered. The Judges may, at their discretion, award a ribbon or rosette.

The Fair reserves the RIGHT TO DETERMINE how many entries they will accept from an Exhibitor in the same class or, in the case of livestock, the same breed, and poultry, the same species.

THE DECISION OF THE JUDGES SHALL BE FINAL IN ALL CASES except where mistakes, fraud, misrepresentation or collusion — not discovered at the time of the award - are proven. In such cases, the Superintendent, President, or Secretary of the Fair, or such referee as he/she may appoint, may make the decision. The case may be appealed to the Fair Management from whose decision there can be no appeal.

All protests regarding judging must be made in writing and must plainly state the cause of the complaint or appeal. Such protests must be filed at the Fair Office within 24 hours of the occurrence.

6. It shall be the responsibility of the Exhibitor TO NAME PROPERLY THE ARTICLE OR BREED OF LIVESTOCK he/she is entering. Any exhibit improperly entered will be disqualified to receive a prize, but the Judges will mark the correct name on the entry tag so the same mistake in entering will not be made the second time.

Every exhibit accepted for premiums must be given an entry tag which must be plainly marked. In cases of livestock, the breed name must be shown and in the case of poultry the species must be shown on cards that can be identified by viewers. Cards will be available at the Secretary's Office; the Exhibitor is responsible for securing, printing, and hanging cards. The award winners must be placed for show. Failure to comply with this regulation will result in forfeiture of premiums.

7. All entries must have been grown, produced, or made since the last Fair by the person whose name appears on the tag as Exhibitor.
8. Superintendents reserve the right to refuse any entry or bar from competition animals, vegetables, flowers, poultry, products, and manufactured articles of decidedly inferior quality and those not possessing sufficient merit to warrant recognition.

(The Superintendent must notify Exhibitors of any exhibits that have wilted or become unfit. After having done this, the Superintendent may dispose of the exhibit.)

9. The Fair Management may, at any time, order the removal of any exhibit or part of exhibit in bad condition, and any article unfit to show may

The Great Stoneboro Fair

be excluded. Food products cannot be polluted with any substances or chemicals that causes them to become poisonous and unfit to be used as food.

NO EXHIBIT MAY BE REMOVED AT ANY TIME BEFORE THE CLOSE OF THE FAIR EXCEPT BY CONSENT OF THE MANAGEMENT.

10. **The Superintendents and/or Show Committee have the authority to require the animals to be shown to be inspected by the Judge.**
11. During the judging, buildings (except livestock arenas) are to be closed to everyone except Fair Officials, Judges, and necessary attendants.

DEPARTMENT SUPERINTENDENTS MAY ENTER EXHIBITS IN THEIR OWN DEPARTMENTS, but neither they nor any other Exhibitor may communicate with the Judges during the time of determining the awards, except to answer questions proposed by Judges.

Any Exhibitor interfering with the Judges while making awards shall forfeit any premium for which she/he would otherwise have been entitled.
12. All livestock offered for premiums must have been the property of the owner for thirty (30) days or longer. (Livestock or poultry entered under a name other than the owner's shall be disqualified for premiums.)
13. No person shall be allowed in the ring while stock is being judged, except the Judge, Superintendents, necessary attendants, and Fair officials.
14. Should any animal awarded a prize be disqualified, the animals gaining the lower prizes shall move into the next higher position if, in the opinion of the Judges, the animals are worthy of such prizes.
15. Overfitting of cattle will be discriminated against. Any artificial means used to change the form or shape of the animal will disqualify the animal from competition.
16. When on exhibit in the ring, each animal must be under halter and under the control of the owner or the employee.
17. Joint ownership is considered to be as one owner in accordance with registration papers.
18. 4-H and F.F.A. livestock entries are **limited to Mercer County residents only. An exception will be made in allowing out-of-county youth to exhibit in the 4-H showmanship.**

An exception will be made in allowing out-of-county youth exhibiting Polled Hereford animals to compete in 4-H and F.F.A. as members of the Northwestern PA Polled Hereford Association.

An exception will be made in allowing Venango County youth exhibiting draft horses to compete in 4-H and F.F.A. as members of the Venango County Draft Horse Association.
19. No Exhibitor may receive more than two monetary awards in each class.
20. Wednesday, August 30th, will be devoted to the reception and arrangement of articles for exhibition. All articles entered for premiums must be placed in the hands of the Superintendent no later than Wednesday, August 28th, by 9:00 PM. **Fine Arts & Rabbit exhibits** must be in place by 8 PM on Tuesday, August 27th 2024.
21. The Fair will provide a central sound system. Other sound equipment will not be allowed on the grounds without permission
22. Vehicles and trailers can be parked in the barn area only for loading and unloading; then they must be moved promptly to designated areas.

The Great Stoneboro Fair

23. All persons shall leave the Fairgrounds by midnight or within 30 minutes after the close of the last show for the day, whichever occurs later, except those persons assisting with the Fair or with exhibits or displays.
24. All campers on the Fairgrounds must be registered at the Fair Office upon entry to the Fairgrounds. Occupants must register at the office and pay a fee of \$75.00 plus \$12 for each air conditioner, Tent \$40.00. ALL CAMPERS WILL BE PARKED IN DESIGNATED AREAS. No campers admitted before 10 AM on Sunday August 25th, 2024, EXHIBITORS ONLY. An application form is included in each premium book.
25. The Fair and its officers or agents will not be responsible for any accident, loss, theft, or damage to persons, animals, vehicles or personal property which may occur.
26. Persons using alcohol or other controlled drugs or substances or engaged in disorderly behavior will be expelled from the grounds.
27. All delivery people and suppliers are requested to be off the midways by 11:00 AM each day of the Fair, and 10:00 AM on Labor Day
28. Buildings will be open from Thursday after judging has been completed, Friday thru Sunday 10:00 AM to 10:00 PM, Monday 9:00 AM to 10:00 PM.
29. NO PETS, leashed or unleashed, (except for Service Animals) will be permitted on the Fairgrounds.
30. Anyone found on Fair property after midnight without a wristband or proof of admittance will be escorted off the grounds.
31. An Exhibitor of items not requiring an entry fee must enter 10 items in order to be eligible to purchase two Exhibitor Wristbands.
32. All animal exhibitors are eligible for two free exhibitor wristbands. They are eligible to purchase up to 10 additional exhibitor wristbands.

OFFICE HOURS

Wednesday, August 7, 2024	9:00 AM - 5:00 PM
Each Weekday, August 17 thru Aug. 27, 2024	10:00 AM - 5:00 PM
Saturday, August 24, 2024	10:00 AM - 3:00 PM
Sunday, August 25, 2024.....	10:00 AM - 5:00 PM
Monday, August 26, 2024.....	10:00 AM - 5:00 PM
Tuesday, August 27, 2024.....	10:00 AM - 9:00 PM
Hours during Fair	10:00 AM - 11:00 PM

**The Fair Office will be open every Wednesday
throughout the year from Noon - 5:00 PM.**

**PREMIUM CHECKS MUST BE PICKED UP LABOR DAY FROM 6PM-
10PM AT THE ENTRY OFFICE, OR YOU CAN SUPPLY A SELF-
ADDRESSED, STAMPED ENVELOPE WITH YOUR ENTRY.**

ADVICE TO LIVESTOCK EXHIBITORS

1. **The deadline for entries is August 07, 2024. All Exhibitors** must make advance entries. Please mail entry forms to The Great Stoneboro Fair, P.O. Box 215, Stoneboro, PA 16153.
2. All entries must be on forms provided by the Stoneboro Fair. Entry forms can be obtained by writing to Patty Adamson, Secretary, @ P.O. Box 215, Stoneboro, PA 16153 or Phone 724-376-2852 or downloaded from the Great Stoneboro Fair website www.stoneborofair.info.
3. There is to be only ONE entry number per person; be sure you show your number when showing.
4. Upon your arrival with stock, the Superintendent of the Department where you are an Exhibitor will assign the stalls your stock will occupy. **DO NOT** take space unless it is assigned to you. **DO NOT ALTER ANY STALLS WITHOUT THE APPROVAL OF THE SUPERINTENDENT.**
5. If you need any information about the Department, go to the Superintendent. The Superintendents will be found at or near their respective Departments and will assist you.
6. Superintendents in charge of Departments have the right to prescribe dimensions and regulate positions of all signs and direct the arrangement of articles to secure harmony and make an attractive appearance.
7. **DO NOT** lock your stables and leave the immediate area. Visitors pay to see your stock, and you are expected to show it.
8. All Exhibitors are to display a farm or owner's sign to identify their breed or breeds of dairy and livestock and must fill out a stall card to identify each exhibit. Exhibitors are responsible for posting these cards. This is required by the Department of Agriculture.
9. **Labor Day is always crowded; however, livestock and dairy animals may be removed from the grounds after 7:00 PM on the last day of the Fair. Other exhibits may be removed at 8:00 PM.**
10. ALL CAMPERs AND RECREATIONAL VEHICLES MUST BE PARKED IN DESIGNATED AREAS.
11. **Absolutely NO raffles or games of chance are permitted in the barns.**

HEALTH RULES AND REGULATIONS

All animals admitted to the Fair shall be identified by a unique and permanent ear tag, tattoo, brand, or records of unique physical attributes. Animals known to be infected with or exposed to any contagious, infectious, or external parasitic disease, and animals restricted by quarantine may not be presented for show purposes.

All animals admitted to the Fair must comply with applicable state (7PA Code) or federal (9CFR) rules.

Animals presented for exhibition will be subject to inspection by show officials and will be rejected if evidence of infectious, contagious, or parasitic disease is apparent or if health certification or identification documentation is not acceptable.

The Great Stoneboro Fair

All show animals should be held in isolation for at least 30 days after return to the herd of origin.

GUIDELINES FOR CARE OF ANIMALS

It is the responsibility of each Exhibitor to care for animals in a manner that is responsible and ethical. Following are some guidelines for the treatment of animals exhibited at the show.

- 1. Restraining Animals**
 - a. Animals should be tied or penned in a manner that will not hurt the animal or restrict its breathing in any way.
 - b. Animals should be tied so that all four feet are firmly on the ground and they have enough room to stand comfortably and lie down.
 - c. Animals should be tied so that they are not able to injure animals tied near them.
 - d. Animals unaccustomed to each other should not be penned together.
- 2. Handling** - Any type of rough handling which could harm the animal is prohibited. The use of whips, canes and show sticks should be restricted to showing only and then be used only to guide the animals, not punish them. Remember, animals will respond quicker and better to quiet, gentle handling, rather than loud, rough handling.
- 3. Bedding** - All animals should have bedding that is dry and clean. Pens should be cleaned regularly to keep the animals clean and comfortable. If non-traditional bedding such as carpeting is used, it should be regularly cleaned (at least twice daily) to keep the pen free from manure.
- 4. Feeding & Water** - Animals should be well-fed and have access to clean water regularly. Realizing that many market animals must have restricted amounts of feed to maintain the proper weight, animals must be fed adequate amounts of feed to meet the animal's basic requirements. Animals not allowed reasonable access to feed and water will be disqualified from the show.
- 5. Transportation** - Animals should be transported in a way that is both safe and considerate of the animal's well-being.
- 6. Blanket/Sweat Collars** - Any type of material such as blankets or sweat collars should be large enough to permit normal body functions such as breathing, eating, drinking, or lying down.
- 7. Health** - It is the responsibility of the Exhibitors to provide proper health care for their animals through routine inspection and consultation with health care professionals. The improper or illegal use of drugs or antibiotics is prohibited. If medication is indicated, be sure to follow the label directions and allow more than the stated withdrawal time.

BIOSECURITY CHECKLIST FOR LIVESTOCK EXHIBITORS

No visitors from a country that has animals infected with Foot and Mouth Disease have visited my farm within the previous 30 days.

Certificates of veterinary inspection are current for all of the animals I will be taking to the Fair. All equipment, such as buckets, pitchforks, shovels, rakes, wheelbarrows, manure baskets, lead ropes, halters, nose rings, snares, clippers, scissors, brushes, etc., has been cleaned and disinfected before entering the fairgrounds. (A solution of household bleach in water is recommended for disinfection purposes: add 2 gallons of bleach to 3 gallons of water for disinfecting equipment.)

- I have received a list of the recommended biosecurity precautions that I should follow after returning to the farm with the animals that were taken to the Fair.
- Any livestock showing signs of illness, including signs that suggest infection with Foot and Mouth Disease, will be reported immediately to the Livestock Superintendent of the Fair.
- Any questions about disease and biosecurity measures can be directed to the regional veterinarian or animal inspector, who will be visiting the Fairgrounds for daily inspections.

Pennsylvania Department of Agriculture regional veterinarians will be visiting each fair in Pennsylvania this season on a daily basis. They will be available to answer questions from Exhibitors and will be doing general inspections of the animals and animal facilities.

NOTICE
ONE WAY TRAFFIC

Entry Day, August 28th, the road from the Main Gate (by the horse barns) to Gate #4 (Stoneboro Gate) will be One-Way Traffic. All Traffic using this road must enter at the Main Gate and Leave at Gate #4.

Labor Day, September 2nd, after 7:00 PM, all traffic using this road must enter at the Main Gate and Leave at Gate #4.

**ATTENTION EXHIBITORS of EQUINE, DAIRY CATTLE,
BEEF CATTLE, SHEEP, and GOATS**

GOOD HOUSEKEEPING AWARDS will be presented to the winning exhibitors in Equine, Dairy Cattle, Beef Cattle, Sheep, and Goat Departments.

Exhibitors will be judged on the following:

- Ribbons & Entry Cards Properly Displayed
- Cleanliness of Animals
- Keeping Hay & Feed Presentable
- Cleanliness of Bedding
- Keeping All Equipment Sanitary & Neat
- Keeping Aisles Clean
- Courtesy To People

1st - \$30.00 2nd - \$20.00 3rd - \$10.00

NOTICE!!!
GATE 1 - MAIN GATE WILL REMAIN OPEN
24 HOURS DURING THE FAIR

THE GREAT STONEBORO FAIR WEB SITE

www.stoneborofair.info

(Additional Entry Forms Available on Site)

THANK YOU!

Wilson Electric

*Auction Winner of the 2023 Great Stoneboro Fair
PA Preferred Junior Baking Cookie, Brownie or Bar
Baking Contest
Baked by Brody Magee*



*Your Support of the 2023 Baked Goods Auction
was greatly appreciated*

**Join Us This Year at 6:00 P.M., Thursday, August 29,
for the 2024 Baked Goods Auction in the Ibbs Building.**

THANK YOU!

Wilson Electric

*Auction Winner of the 2023 Great Stoneboro Fair
Homemade Chocolate Cake Contest
Baked by Barbara Dye*



*Your Support of the 2023 Baked Goods' Auction
was greatly appreciated*

**Join Us This Year at 6:00 P.M., Thursday, August 29,
for the 2024 Baked Goods Auction in the Ibbs Building.**

DEPARTMENT 1 - HORSES

Superintendent, Jim Uber
Kelly Beach

Phone (724) 813-3049
Phone (724) 967-1774

ALL ANIMAL ENTRIES ARE REQUIRED TO MEET THE 2023 PENNSYLVANIA DEPARTMENT OF AGRICULTURE ANIMAL HEALTH REQUIREMENTS AND RECOMMENDATIONS FOR ANIMALS FOR EXHIBITION AS LISTED IN THE BACK OF YOUR PREMIUM BOOK. **ALL HORSES ALSO REQUIRE RABIES SHOTS**

HEALTH REQUIREMENTS RULES AND REGULATIONS

1. Check-In is Tuesday, August 27, 2024, from 6-9 PM. All equine animals must come through the main gate. No animal will be unloaded until the veterinarian or Superintendent has given the approval upon verifying the required paperwork. All animals are to remain on the premises until September 2, 2024, at 7:00 PM unless released by the Superintendent.
2. The Fair reserves the right to refuse any or all entries, and the right to order any Exhibitor to remove stock for failure to follow rules of the Department.
3. All animals entered must be shown in at least ONE HALTER CLASS and stabled on the grounds and must have met all health requirements.
4. Exhibitors must keep stalls and space they occupy in a clean and sanitary condition and must remove equipment promptly as the Superintendent may direct.
5. Stalls will be awarded based on registration date. There will NOT be a choice of stalls. Moving of stall tags by an Exhibitor may result in expulsion of Exhibitor without refund of entry fees.
6. Stall guards will be required on all stalls for the safety of horses and attendees.
7. If you wish to repair, rebuild, paint, or otherwise improve the condition of your stall, you must first have approval of the Superintendent and Director of Maintenance.
8. Exhibitors must post stall cards.
9. No grade stallions--exception stallion foals. No one UNDER 18 years of age is to handle a stallion.
10. Horses may be purebred or grade but must be shown in the appropriate class.
11. Equine animals are NOT permitted to enter the midway area at any time and must stay off the racetrack. All horses must be led to the exercise area. **Horses may not be exercised outside of the arena.**
12. The order of show will not necessarily correspond to the order of classes appearing in the premium book.
13. No class changes may be made after entry day. NOTE: The same entry number can NOT be in the same class/nor show ring at the same time. NO EXCEPTIONS! ALSO: the same horse can NOT be shown in the same class by two different people. NO EXCEPTIONS!!!
14. The Judge's decision is final on ALL shows including 5 minute time limit on gate call.
15. If the number of entries does not warrant all listed classes, classes may be combined, (except champion classes).
16. All 4-H and FFA members' animals must be entered and shown in the 4-H and FFA members' names. All 4-H and FFA youth will stay in the ring at the close of the class for awards.
17. Youth drivers must be accompanied by an adult for safety reasons. All youths 10 years of age and under handling equine animals must be accompanied by an adult at all times outside of the show ring.
18. All youths (18 and under) must wear an approved helmet, long pants, and hard-soled shoes.
19. Adults must wear hard-soled shoes; no bare feet or open shoes will be permitted. Adults are permitted to help with handlers who are younger than eight years of age.

The Great Stoneboro Fair

20. The Judge or Show Management shall have the authority to dismiss any entry from the ring if the entry is not under sufficient control.

IT IS THE RESPONSIBILITY OF THE EXHIBITOR TO HAVE HIMSELF OR HERSELF READY AT THE PROPER TIME AND PLACE FOR JUDGING. CLASSES WILL NOT BE HELD UP FOR LATE ARRIVALS TO THE SHOW RING.

**Thursday 6:00 PM
All Equine Costume Class
Followed by Extreme Trail Challenge**

- **Mounted Competitors Only**
- **Class will be judged on accuracy as well as time**
- **No entry fee - Ribbons Only**
- **Adult riders 18 & older**
- **Youth riders 17 & under**

**Friday-10:00 AM
SECTION 1
PONIES & MINIATURE HORSES (Under 56")**

\$2 entry fee per class

Premiums \$10, \$8, \$6, \$4

**ALL HORSES & PONIES MUST COME THROUGH THE
MAIN GATE ON ENTRY DAY!!!**

- A. Miniature Horse (38" or under)
 - B. Pony (OVER 38" under 56")
 - C. Mini Burro/Donkey
 - D. Mini Mule
1. Stallion 4 and over
 2. Stallion under 4
 3. All Breeds Champion and Reserve Stallion (Rosette only)
 4. Gelding 4 and over
 5. Gelding under 4
 6. All Breeds Champion and Reserve Gelding (Rosette only)
 7. Mare 4 and over
 8. Mare under 4
 9. All Breeds Champion and Reserve Mare (Rosette only)
 10. Mare and Foal
 11. Produce of Dam - two animals ANY Age OR Sex regardless of ownership
 12. Get of Sire - two animals ANY Age or Sex regardless of ownership

The Great Stoneboro Fair

Friday-5 PM

SECTION 2

Miniature Equine FUN SHOW

Entry fee \$5 per horse / handler (unlimited classes)

(no switching DURING show)

Ribbons Awarded through 4th place

1. Adult Jumping
2. Youth Jumping
3. Pee Wee Halter
4. Adult Pole Bending
5. Youth Pole Bending
6. Pee Wee Pole Bending*
7. Adult Barrels
8. Youth Barrels
9. Pee Wee Barrels*
10. Adult Crawl Through Barrels
11. Youth Crawl Through Barrels
12. Pee Wee Crawl Through Barrels*
13. Adult Egg & Spoon
14. Youth Egg & Spoon
15. Pee Wee Egg & Spoon*

*A Pee Wee is 8 years of age & under.

A Pee Wee MUST have an adult in the ring with her/him.

Pee Wee age is of January 1, 2024.

In Memory of Bill, Margaret, & Ron Thompson

Saturday-5:00 PM

SECTION 3

DRAFT HORSES & HAFLINGERS

\$2 ENTRY FEE PER CLASS

Premiums \$25, \$20, \$15, \$13

- A. Belgian
- B. Percheron
- C. Haflinger

- D. Other Draft
- E. Grade Draft Pony (no stallions)
- F. Mule

1. Stallion 4 and OVER
2. Stallion UNDER 4
3. All Breed Champion & Reserve Stallion (Rosette ONLY)
4. Gelding 4 and OVER
5. Gelding UNDER 4
6. All Breed Champion & Reserve Gelding (Rosette ONLY)
7. Mare 4 and OVER
8. Mare UNDER 4
9. All Breed Champion & Reserve Mare (Rosette ONLY)

The Great Stoneboro Fair

10. Mare & Foal
11. Produce of Dam - two animals any Sex or Age regardless of ownership
12. Get of Sire - two animals any Sex or Age regardless of ownership

Saturday – 5:00 PM

SECTION 4

Draft Horses & Haflingers

Hitch & Obstacle Classes

Following the Halter Classes

\$2 Entry fee per class

Premiums Single Hitch \$22, \$12, \$8, \$5

Team & Tandem Hitch \$32, \$20, \$12, \$5

Entry may be shown (**ONLY**) once per class.

Youth -18 and under

1. Light Horse 50" & OVER - Single Hitch - Adult Driver
2. Light Horse 50" & OVER - Single Hitch - Youth Driver
3. Draft Horse Single Hitch - Male Driver
4. Draft Horse Single Hitch - Female Driver
5. Draft Horse Single Hitch - Youth Driver
6. Open Horse 50" and OVER - Tandem Hitch - Adult Driver
7. Four Horse Tandem Hitch – Adult Driver
8. Light Horse 50" & OVER - Team Adult Driver
9. Light Horse 50" & OVER - Team Youth Driver
10. Draft Horse TEAM - Adult Driver
11. Draft Horse TEAM - Youth Driver
12. Mini/Pony Hitch 38" & UNDER – Team Hitch
13. Open Horse OVER 38" & Under 50" – Team Hitch
14. Mini/Pony Hitch 38" & UNDER – Tandem Hitch
15. Open Horse OVER 38" & UNDER 50" Tandem Hitch
16. Mini/Pony Hitch 38" & UNDER – Single Hitch- Adult
17. Mini/Pony Hitch 38" & UNDER – Single Hitch- Youth
18. Open Horse OVER 38" & UNDER 50" Single Hitch
19. 6 Horse Draft Hitch
20. 38" & UNDER 6 Horse Hitch
21. Ride a Draft

NEW RULE

**NO ONE IS PERMITTED IN ANNOUNCER'S STAND EXCEPT ANNOUNCER,
BOOKKEEPER, SUPERINTENDENT, & ASSISTANT SUPERINTENDENT UNLESS
APPROVED BY SUPERINTENDENT**

The Great Stoneboro Fair

Sunday-10 AM SECTION 5 LIGHT HORSES (56" AND OVER)

\$2 ENTRY FEE PER CLASS

Premiums \$15, \$12, \$10, \$8 - Ribbons Awarded Through 4th place

- | | |
|------------------|----------------------------|
| A. Arabian | E. Paint |
| B. Saddlebred | F. Other Breed |
| C. Morgan | (Enter ONLY if not listed) |
| D. Quarter Horse | G. Grade (no Stallions) |
1. Stallion 4 and OVER
 2. Stallion UNDER 4
 3. All Breed Champion and Reserve Champion Stallion (Rosette ONLY)
 4. Gelding 4 and OVER
 5. Gelding UNDER 4
 6. All Breed Champion - and Reserve Champion Gelding (Rosette ONLY)
 7. Mare 4 and OVER
 8. Mare UNDER 4
 9. All Breed Champion
 10. Mare and Foal
 11. Produce of Dam – two animals any Age or Sex regardless of ownership
 12. Get of Sire – two animals any Age or Sex regardless of ownership

Sunday Following Halter Show

SECTION 6

LIGHT HORSES AND PONIES FUN SHOW

\$2 ENTRY FEE PER CLASS (no fee for lead line)

Premiums \$10, \$8, \$6, \$4 - Ribbons Awarded Through 4th place

1. Lead Line (Ribbon ONLY)
2. Sr. Pleasure
3. Jr. Pleasure
4. Pee Wee Walk–Trot Pleasure
5. Sr. Equitation
6. Jr. Equitation
7. Pee Wee Walk-Trot Equitation
8. Jr. Egg & Spoon
9. Sr. Egg & Spoon
10. Cakewalk – OPEN – (Walkers Welcome)
11. Sr. Barrels
12. Jr. Barrels - Trophy - sponsored by Sundance Arena Rodeo
13. Open Flag Race
14. Catalog Race
15. Sr. Horse Poles
16. Jr. Horse Poles
17. Sr. Keyhole
18. Jr. Keyhole
19. Sr. Thread the Needle
20. Jr. Thread the Needle
21. Open End Barrel Race
22. Dollar Bareback

2024 Horse Dept. Sponsor

Mercer County Antique Power Association

Friends of 2024 Horse Dept.
H & H Inc.
Tractor Supply

Levi & Sue Byler



1274 N Perry Hwy
Mercer, PA
724-475-3050



Over 50 years of
Pumps, Tanks, and
Conditioning Equipment
Sales and Services
www.palmerpoolsales



Hicks Auto Service

State Inspection and General Repair

(724) 376-3906

4119 Sandy Lake Rd.
Sandy Lake, PA 16145

HEALTH REQUIREMENTS FOR CATTLE

ALL ANIMAL ENTRIES ARE REQUIRED TO MEET THE 2024 PENNSYLVANIA DEPARTMENT OF AGRICULTURE ANIMAL HEALTH REQUIREMENTS AND RECOMMENDATIONS FOR ANIMALS FOR EXHIBITION AS LISTED IN THE BACK OF YOUR PREMIUM BOOK. **ALL HORSES ALSO REQUIRE RABIES SHOTS.**

Foot and Mouth Disease (FMD)

Foot and Mouth Disease (FMD) is an extremely contagious viral disease that affects cloven-hooved animals, especially domestic cattle, pigs, sheep, and goats. FMD is rarely fatal to infected adult animals, but causes pain and suffering to those animals, which leads to a severe drop in production. The disease can be devastating to the economy of an infected state and country.

The first signs of FMD in animals which are usually noticed:

Lameness

Decreased feed intake

Both are a result of pain from the blisters and sores caused by the virus.

Infection with FMD causes:

Blisters, Fever, Excessive Salivation, Abortions, Decreased Milk Production, Weight Loss

Disinfection

The virus that causes FMD can be inactivated by several disinfectants, including household bleach. It can be killed by extremes in PH (below ph6 and above ph1) by sunlight, and high temperatures, although the virus has been shown to survive single pasteurization at 161.6 degrees F (15 seconds). It can survive in the environment at freezing temperatures: It can survive in the soil for almost a month in cool weather; about three days during the sunny, summer months. It may even live in stored hay for up to four to five months in cool, dry conditions.

Transmission of Foot and Mouth Disease

Although Foot and Mouth Disease does not pose a serious risk to human health, humans can act as vectors for the virus and can spread infection among animals or between farms. Methods of transmission of FMD include:

Droplets: Direct contact with clinically ill, recovered (carrier) animals, or exposed vaccinated animals: Virus particles can be found in body fluids, including urine, feces, saliva, semen, and milk, and also in exhaled breath.

People: The FMD virus can survive in the lungs and nasal passages of humans for several days, and in the tonsils for several weeks. Virus particles are released and can infect susceptible animals when the person exhales.

Clothing: Virus particles can survive on contaminated clothing (the FMD virus can survive for several weeks on clothes and shoes, especially if these articles are dirty).

Other animals: Movement of pets or other animals through an infected area can spread the virus.

Food Products: Contaminated meat and cheese products can spread the virus.

Air: Airborne virus particles might be carried in air currents for up to 40 miles.

DEPARTMENT 2 - DAIRY CATTLE

Superintendent

Don Jones (724) 372-0165

Assistant Superintendents Kevin Minor & Bobby Minor, Eric Ligo

Entry Fee to be Paid at Time of Entry - \$2.00 per cow in Open Shows

ALL ANIMAL ENTRIES ARE REQUIRED TO MEET THE 2024 PENNSYLVANIA DEPARTMENT OF AGRICULTURE ANIMAL HEALTH REQUIREMENTS AND RECOMMENDATIONS FOR ANIMALS FOR EXHIBITION AS LISTED IN THE BACK OF YOUR PREMIUM BOOK. **ALL HORSES ALSO REQUIRE RABIES SHOTS**

DUE TO LIMITED SPACE, MAKE YOUR ENTRIES EARLY.

1. Exhibitors will be expected to display or parade their animals as directed by the Superintendent: (a) to accept the stall assigned without controversy, (b) to keep their animals in an attractive appearance, and (c) to cooperate with the Department in every way that may serve to increase the educational value of the show.
2. It is the responsibility of the Exhibitors of livestock to know when their stock will be judged. Stock must be in the ring promptly on call, and a failure to comply with the order renders Exhibitors liable to be ruled out of competing. Decorations with ribbons or ornaments previously won by animals at shows will be prohibited until after the awards have been made in their respective classes by the Judge.
3. Exhibitors must have all animals listed for competition on the grounds not later than August 28 @ 5:00 PM. All such animals are to remain on the premises until Labor Day, 7:00 PM, unless released by the Superintendent.
4. The Exhibitors will be expected to keep the space they occupy in a clean and sanitary condition and to remove all their equipment promptly as the Superintendent may direct.
5. Dairy Cattle will be shown on Friday, beginning at 8:30 am in the following order: Jersey, Holstein, Guernsey, Milking Shorthorn, Brown Swiss, Ayrshire. Each breed will start with Bull Calf class. All Bull classes in that breed will be shown and then will start with spring calf of that breed and then the entire breed will be shown before moving on to the next breed. At the conclusion of ALL breeds showing the Champions from each breed will compete for Supreme Cow and Supreme Jr of the Show.
6. All 4-H and Open class animals will remain in the ring after each open class is judged for the awarding of prizes in the area of YOUTH CONTESTS. All animals must be entered in the Exhibitor's name and be shown by a 4-H YOUTH.
7. Exhibitors must fill out and display stall cards for each animal. Secure cards from the Secretary at the time of checking entries. Cards must be displayed prior to showing. Have registration papers with you. Some classes will be spot-checked.
8. All 4-H Showmanship will be held on Friday after the type classes are concluded. Participants do NOT have to wear whites; however appropriate attire preferably jeans and Fair t-shirt and boots or appropriate footwear are required. If 4-H premiums are being collected it is mandatory for 4-H Exhibitors to show in showmanship competition directly after the type show on Friday. Exception may only be made by the Dairy Superintendent prior to the show. Exhibitors will be given the opportunity to make any changes or corrections to their entries on Thursday evening from 6-8 pm at the milking parlor. Minimal changes will be made during the show.

MILKING CENTER REGULATIONS

The facilities and equipment at the "Milking Center" are provided for the exclusive use of the Exhibitors of milking dairy cows and are to be used for milking ONLY. There shall be NO clipping or washing of cattle or any other livestock, other than udder washing as a preparation for milking. The Milking Center washing equipment and water shall not be used for any other purpose. No milk from animals being treated with antibiotics shall be introduced into the milking system.

The Great Stoneboro Fair

Any person entering a milking cow at the Fair, by his/her entry, gives the Dairy Superintendent or designee the authorization to sample milk from that cow periodically for the purpose of antibiotic testing.

All milk from the milking center will be sold to a milk handler selected by the Dairy Superintendent with payment made to dairy cattle Exhibitors.

The milking center will be open for use between the hours of 7:00 AM to 9:00 AM, and 7:00 PM to 9:00 PM each day of the Fair with the exception of the evening prior to the show and show day when off-hour milking is necessary for show preparation.

The Dairy Parlor Superintendent shall establish additional rules as he/she may deem necessary and such rules will be posted at the Milking Center.

SECTION 1

A - Ayrshire

MS - Milking Shorthorn

B - Brown Swiss

H - Holstein

G - Guernsey

J - Jersey

OPEN CLASSES - DAIRY CATTLE

Class

1.	Junior 2 Year Old born between March 1, 2022 & August 31, 2023.....	\$25	\$20	\$16	\$14
2.	Senior 2 Year Old born between Sept. 1, 2021 & Feb. 28, 2022	\$25	\$20	\$16	\$14
3.	Junior 3 Year Old born between March 1, 2021 & Aug. 31, 2022.....	\$25	\$20	\$16	\$14
4.	Senior 3 Year Old born between Sept. 1, 2020 & Feb. 28, 2021	\$25	\$20	\$16	\$14
5.	Dry Cow 3 and 4 Years Old born between Sept.1, 2019 & Aug. 31, 2020	\$25	\$20	\$16	\$14
6.	Dry Cow 5 Years Old and over born before Sept. 1, 2018	\$25	\$20	\$16	\$14
7.	4 Year Old Cow in Milk, born between Sept. 1, 2019 & Aug. 31, 2020	\$25	\$20	\$16	\$14
8.	5 year Cow in Milk, born before Sept. 1, 2019	\$25	\$20	\$16	\$14
9.	6 year and Over Cow in Milk, born before Sept. 1, 2018	\$25	\$20	\$16	\$14
10.	Senior Champion Female	Rosette			
11.	Reserve Senior Champion Female.....	Rosette			
12.	Cow, any age, to be judged on udder alone	\$25	\$20	\$16	\$14
13.	Senior Get-of-Sire, 3 animals 2 years old or over, all by one Sire, not more than one bull, need not be owned by one herd.....	\$30	\$25	\$20	\$15
14.	Dairy Herd - 3 cows that have freshened, carrying the same prefix. Limit 1 entry per Exhibitor.....	\$30	\$25	\$20	\$15
15.	Bull Calf born between Sept. 30, 2023 and May 31, 2024	\$14	\$12	\$9	\$6

THANK YOU to our Dairy Cattle Dept. Sponsor Pruskowski Trucking

The Great Stoneboro Fair

16. Junior Yearling Bull born between Mar. 1, 2023 & August 31, 2023.....	\$14	\$12	\$9	\$6
17. Senior Yearling Bull born between Sept. 1, 2022 & Feb. 28, 2023	\$14	\$12	\$9	\$6
18. Grand Champion Bull.....	Rosette			
19. Reserve Grand Champion Bull.....	Rosette			
20. Junior Heifer Calf born between Mar. 1, 2024 & May 31, 2024	\$14	\$12	\$9	\$6
21. Intermediate Heifer Calf born between Dec. 1, 2023 & Feb. 28, 2024	\$14	\$12	\$9	\$6
22. Senior Heifer Calf born between Sept. 1, 2023 & Nov. 30, 2023	\$14	\$12	\$9	\$6
23. Summer Yearling Heifer born between June 1, 2022 & August 31, 2022.....	\$18	\$16	\$14	\$12
24. Junior Yearling Heifer born between March 1, 2023 & May 31, 2023.....	\$18	\$16	\$14	\$12
25. Intermediate Yearling Heifer born between Dec.1, 2022 & Feb. 28, 2023	\$18	\$16	\$14	\$12
26. Senior Yearling Heifer born between Sept.1, 2022 & Nov. 30, 2022	\$18	\$16	\$14	\$12
27. Junior Champion	Rosette			
28. Reserve Junior Champion.....	Rosette			
29. Junior Get-of-Sire, 3 animals under 2 years, all by one Sire, not more than one Bull, need not all be owned by one Exhibitor	\$20	\$18	\$16	\$14
30. Junior Best 3 Females, under 2 years old, bred and owned by Exhibitor	\$20	\$18	\$16	\$14
31. Grand Champion Female	Rosette			
32. Reserve Grand Champion Female.....	Rosette			
33. Best 3 Females, any age, bred and owned by Exhibitor, limit one entry per family - sponsored by the Philson Family In Memory of Jack & Bonnie Philson	\$30	\$25	\$20	\$15
34. Produce of Dam - 2 animals any age, either sex, the produce of one cow, need not be owned by one Exhibitor. Limit 1 per exhibitor Holstein.....	\$30	\$25	\$20	\$15
35. Dam and Daughter, any age, need not be owned by one Exhibitor. Limit 1 per exhibitor Holstein	\$30	\$25	\$20	\$15
36. Supreme Champion Dairy Cow - Banner - \$100 Courtesy of the Milk Fund All breed Champions competing.....	**Must be milked**			
37. Supreme Jr. Champion - Banner - All breed Jr. Champions competing Sponsored by Book Family Seed Sales				

**The same classifications and premiums stated above apply to each breed.
(See Listing Section 1 - Dept. 2)**

**Thank You to our Dairy Cattle Dept.
Sponsor Sandy Lake Auto Parts
And Pruskowski Trucking**

DEPARTMENT 3 - Beef Cattle

Superintendents: Eric Ligo & Dave McCullough & Bobby Minor

ALL ANIMAL ENTRIES ARE REQUIRED TO MEET THE 2024 PENNSYLVANIA
DEPARTMENT OF AGRICULTURE ANIMAL HEALTH REQUIREMENTS AND
RECOMMENDATIONS FOR ANIMALS FOR EXHIBITION AS LISTED IN THE BACK OF
YOUR PREMIUM BOOK. **ALL HORSES ALSO REQUIRE RABIES SHOTS**

Entry Fee: \$2.00 per Cow in Open Shows - Groups excluded, Fee to accompany Entries.

1. Joint ownership considered to be as one owner in accordance with registration papers.
2. When on exhibition in the ring, each animal must be under halter and in the charge of the owner or owner's representative.
3. 4-H and F.F.A. animals are eligible for the open class.

SECTION 1

BREEDING ANIMALS

- | | |
|---|-------------------------|
| A - Angus | S - Shorthorn |
| C - Charolais | SM - Simmental |
| H - Hereford (horned or polled competing) | O - Others by Breed |
| OC – Crossbred | OA - Aberdeen |
| | OSH - Scottish Highland |

Class

1. Junior Bull Calf - calved after Jan. 1, 2024.....	\$17	\$12	\$8	\$6
2. Senior Bull Calf - calved between Sept. 1 and Dec. 31, 2023.....	\$17	\$12	\$8	\$6
3. Summer Yearling Bull - calved between May 1 & Aug. 31, 2023.....	\$17	\$12	\$8	\$6
4. Junior Yearling Bull - calved between Jan. 1 & Apr. 30, 2022.....	\$18	\$12	\$10	\$5
5. Senior Yearling Bull - calved between Sept.1 & Dec. 31, 2022.....	\$18	\$12	\$10	\$5
6. 2-Year-Old Bull - calved between Jan. 1 & Aug. 31, 2022.....	\$20	\$15	\$10	\$6
7. Champion Bull (first place bulls competing)				Rosette
8. Reserve Champion Bull (first place bulls and second place to champion				Rosette
9. Two Bulls owned by Exhibitor.....	\$20	\$15	\$10	\$6
10. Junior Heifer Calves - calved after Mar.1, 2024.....	\$17	\$12	\$8	\$6
11. Junior Heifer Calves - calved between Jan.& Feb. 28, 2024.....	\$17	\$12	\$8	\$6
12. Late Senior Heifer Calves - calved between Nov. 1 & Dec. 31, 2023.....	\$17	\$12	\$8	\$6
13. Senior Heifer Calves - calved between Sept. 1 & Oct. 31, 2023.....	\$17	\$12	\$8	\$6
14. Senior Yearling Heifer - calved between July 1 & Aug. 31, 2023	\$17	\$12	\$8	\$6

THANK YOU to our Beef Cattle Dept. Sponsor Pruskowski Trucking

The Great Stoneboro Fair

15. Summer Yearling Heifer - calved between May 1 & June 30, 2023	\$17	\$12	\$8	\$6
16. Junior Yearling Heifer - calved after Mar.1, 2023	\$17	\$12	\$8	\$6
17. Early Junior Yearling Heifer - calved between Jan. 1 & Feb. 28, 2023	\$17	\$12	\$8	\$6
18. Senior Yearling Heifer - calved between Sept.1 & Dec. 31, 2022.....	\$20	\$15	\$10	\$8
19. 2-Year-Old Heifer - with calf at side between Jan. 1 and Aug. 31, 2022	\$20	\$15	\$10	\$8
20. 2-Year-Old Heifer - NOT calved between Jan.1 and Aug. 31, 2022.....	\$20	\$15	\$10	\$8
21. Females 3-Years and up, with a calf at side ...	\$20	\$15	\$10	\$8
22. Champion Female (First place Female competing) \$25 Sponsored by Gander & Girls Family Farm				
23. Reserve Champion Female (First Place Female and Second Place to Champion).....	Rosette			
24. Get of Sire; four animals from above classes, BOTH Sexes represented need not be owned by Exhibitor	\$20	\$15	\$10	\$8
25. Junior Get of Sire; Three animals BOTH Sexes represented, from classes 1, 2, 3, 10, 11, 12, 13, 14, or 15, need not be owned by Exhibitor				
26. Supreme Champion Beef (Female) -Breeding Animals				
27. Supreme Champion Beef (Bull).....	Rosette			

SECTION 2 OPEN CLASS STEERS

List Breed and Weight On Entry Blank Market Steers

Class

1. Light Weight - Under 900 lbs.	\$16	\$12	\$10	\$8	\$6
2. Medium Weight - 900-1100 lbs.	\$16	\$12	\$10	\$8	\$6
3. Heavy Weight - over 1100 lbs.	\$16	\$12	\$10	\$8	\$6
4. Breed Champion	Ribbon				
5. Grand Champion.....	Rosette				

1. Classes may be provided for the following Breeds:

A - Angus	H - Hereford
C - Charolais	O - Others, by Breed, if 3 or more entries per breed
S - Shorthorn	SM - Simmental

2. Crossbred steers shall be classified according to the breed of the Sire.
3. Due to weight variances and weight limits, the number of weight classes will be set by the Fair. Try to enter in classes 1, 2 or 3 above.
4. Beef steers shall be free of infectious and transmissible diseases. Shipping fever shots required.
5. Crossbred Steers sired by breeds other than those listed to be shown in one class or special classes may be provided by sanction of Fair Directors and Superintendent as above.
6. Beef cattle must have completed CVI Form and a completed Relationship Form located on the back of the entry form.

The Great Stoneboro Fair

The same classification and premiums as stated above apply to each breed. Joint ownership is to be considered one owner in accordance with registration papers.

Registration papers may be checked. Have them with you! No Exhibitor may enter more than two animals per class.

Only nationally recognized breeds will be eligible to show in breeding classes. Animals shown in breeding classes are not eligible for market classes.

Awards:

Supreme Champion Ram - Blanket presented by Kress Auto Center

Supreme Champion Ewe - Blanket presented by Kress Auto Center

SECTION 2 OPEN CLASS MARKET LAMBS

1. Light Weight: 85-100 pounds
 2. Medium Weight: 101-120 pounds
 3. Heavy Weight: 121-140 pounds
 4. Champion Market Lamb..... Rosette
 5. Reserve Champion Market Lamb Rosette
- PREMIUMS** \$10.00 \$8.00 \$6.00 \$5.00
1. All health rules pertaining to breeding sheep will apply to market lambs.
 2. The Fair reserves the right to divide the three classes differently, based on animals entered.
 3. Animals shown in market classes are not eligible for breeding classes.

SECTION 3 WOOL SHOW

Purpose: to encourage the production of better wool, to promote proper handling, grading, and preparation for market; to create an awareness of the many qualities of wool and its uses.

SPECIFIC WOOL SHOW RULES:

1. Arrival time: All fleeces must be in place by 9:00 PM on Wednesday, August 28th. Entries will be judged Thursday, August 29th.
2. All wool exhibited must be shorn within 12 months of the show.
3. All fleeces entered in purebred classes must have been removed from purebred sheep recorded in their respective registry association.
4. All fleeces must have been grown on sheep owned by Exhibitor and shown under his/her name.
5. Exhibitors are limited to two premiums per class.
6. All fleeces must be tied with twine or packaged in clear, heavy duty plastic bags. Fleeces containing excessive amounts of foreign matter such as burrs, tags, chaff, straw, etc., may be excluded from receiving a premium if Judge so deems fleece not worthy of an award. Each fleece must be tagged with the following information: Name-Breed-Class.
7. All Exhibitors must claim fleeces at the close of the show. Release time is 9 PM on Monday, Labor Day.

COME AT 5, EAT AT 6, PARTY AT 7!!

2024 MAPLE LANE FARM BARN PARTY WILL BE HELD ON SEPTEMBER 7TH

THIS IS THE 18TH YEAR FOR THIS GATHERING, AN EVENT YOU DON'T WANT TO MISS!

WE'VE PARTNERED WITH MLH DISTILLERY AND HERITAGE WINE CELLARS!
THEY WILL BE ON-SITE SERVING THEIR SPIRITS AND WINE!

Tickets are \$75 (presale) OR \$100 (at the door) - includes appetizers from Main Street Diner, Stoneboro Fireman's Fries, dinner catered by Weber-Whiting & delicious ice cream for dessert!

BUSINESS OWNER OR WANT RESERVED SEATING?



PURCHASE A TABLE OF (8) FOR \$800 DESIGNATED FOR YOUR COMPANY (OR PERSONAL NAME), INCLUDING COMPLIMENTARY PARTY FAVORS!

Purchase Tickets online! Go to www.eventbrite.com - search 'Maple Lane Farm' to find our event.

Tickets/tables can also be purchased at Brian Ralph's Allstate office at 238 Oak St. in Grove City.

Online Ticket sales end September 5th @ 5pm. Limited tickets are available at the door the night of the party.

***** **BE A BRONZE, SILVER, GOLD OR PLATINUM SPONSOR!** *****

- 1.) **BRONZE \$500** 2.) **SILVER \$1,000** 3.) **GOLD \$2,000** 4.) **PLATINUM \$3,000**

*Silver sponsorship includes (2) tickets, Gold sponsorship includes (4) tickets, and Platinum sponsorship includes a reserved table for 8 and business or personal logo prominently displayed on the front of the program! All levels of sponsorship include your business or personal name being displayed on a sign the evening of the party as an extra thank you for your support.

PLEASE DONATE TO OUR LIVE OR SILENT AUCTIONS!

WE AUCTION OFF A VEHICLE DONATED BY CHEVY ALL STARS AND DIEHL
CHEVROLET EVERY YEAR AND SO MUCH MORE!!!

THE 2023 MAPLE LANE FARM BARN PARTY RAISED OVER \$40,000
AND WAS ABLE TO DONATE TO OVER 28+ LOCAL CHARITIES!



If you want more info on sponsorship, purchasing a table, tickets, or donating - please contact Brandy Ralph:
brandyrouse@allstate.com - call or text 724-967-5000 or stop into the Allstate office in Grove City.

*Tax-deductible donation of \$40 for a table & \$40 for individual ticket
*Maple Lane Farm Charitable Foundation is a component fund of the Community Foundation of Western PA & Eastern OH #20240003

WE NOW ACCEPT CASH, CHECK AND CREDIT CARDS TO PURCHASE AUCTION ITEMS!

The Great Stoneboro Fair

SECTION 2 - Meat Goats

PREMIUMS	\$10	\$8	\$6	\$5
Class				

1. Light weight up to 60 lbs
 2. Med. weight up to 90 lbs
 3. Heavy weight over 90 lbs
1. All health rules pertaining to breeding goats will apply to market kids.
 2. The Fair reserves the right to divide the three classes differently, based on animals entered.
 3. Animals shown in market classes are not eligible for breeding classes.

**Thank You to our Goat Dept. Sponsor
McCartney's Feed Mill & Hardware**

watson's *Inc*



MASSEY-FERGUSON



PHONE 724-346-6514
Hours: Mon-Fri 8 AM - 5 PM
Sat 8 AM - Noon

7130 East State Street, Hermitage, Pa 16148
Sharon - Mercer Road

DEPARTMENT 8 - POULTRY

Department Head: Tom Schaffer Ph. (724) 376-3186

In Memory of: Tom McCullough

To ensure a cage reservation, entries MUST be in by August 7, 2024. Sawdust will be furnished by the Fair Association. Feed to be furnished by the Fair Association, donated by McCartney's Feed Mill, Fredonia, PA, Sandy Lake Mills, Sandy Lake, PA, and Tractor Supply, Greenville, PA.

Since all birds returned from the show are potential sources of infection to other birds, they should be isolated immediately after their return, separate and apart from other birds. This isolation should be maintained indefinitely, if possible, or at least until it has been established that the birds are not carriers of disease producing agents. This may be determined by exposure of a few susceptible birds in direct contact with them.

NOTE: Health certificate forms may be secured from the Department of Agriculture, Bureau of Animal Industry. All birds entered for exhibition shall be free of external parasites (lice, mites, etc.).

*** Avian Flu might necessitate cancellation of Poultry Exhibit.**

RULES

1. There will be **\$.50** entry fee on each entry and must accompany the entry blank.
2. Exhibits shall be open to Crawford, Mercer, Butler, Lawrence, and Venango counties. Then if space permits, additional entries from other counties will be accepted on a "first-come-first-serve basis." When cooping capacity has been reached, the remaining entries will be returned. Entries are limited to 75 birds per family in Mercer County, and other counties 50 birds per family.
3. All birds being judged for prize money must be pure breed, with the exception of Capons.
4. All poultry must be owned by Exhibitor for a minimum of 30 days prior to the Fair.
5. A class will be provided for all breeds of Chickens, Bantams, Ducks, Geese, and Guinea Fowl as shown on the breed classification list.
6. Birds will be judged according to the American Standard of Perfection and due consideration will be given to the utility qualities, especially to those varieties that are generally used for commercial purposes.
7. The cage capacity for the Poultry Department is 500 entries.
8. Any bird entered in incorrect class will be disqualified.
9. Entries limited to 2 birds in each class per Exhibitor.
10. All 4-H members entering poultry must follow all rules and can receive 4-H and open premiums.

HEALTH REQUIREMENTS

ALL ANIMAL ENTRIES ARE REQUIRED TO MEET THE 2024 PENNSYLVANIA DEPARTMENT OF AGRICULTURE ANIMAL HEALTH REQUIREMENTS AND RECOMMENDATIONS FOR ANIMALS FOR EXHIBITION AS LISTED IN THE BACK OF YOUR PREMIUM BOOK. ALL HORSES ALSO REQUIRE RABIES SHOTS

**BREED CLASSIFICATION NUMBERS MUST BE USED.
CONTACT TOM SCHAFFER 724-376-3186.**

AMERICAN	1138 Silver Penciled	Sussex
Code Breed-Variety	1139 White	1261 Light
1011 Buckeye-		1262 Red
Chanicleler	ASIATIC	1263 Speckled
1021 Partridge	Brahma	MEDITERRANEAN
1022 " - White	1151 Buff	Ancona
1031 Delaware	1152 Dark	1311 Rose Comb
1041 Dominique	1153 Light	1312 Single Comb
Holland	Cochin	1321 Andalusian -Blue
1051 Barred	1161 Barred	1331 Catalana -Buff
1052 " - White	1162 Black	Leghorn
1061 Java - Black	1163 Blue	1341 Rose Comb (Black)
1062 " - Mottled	1164 Brown	1342 Rose Comb (Buff)
Jersey Giant	1165 Buff	1343 Rose Comb (Dark Brown)
1071 Black	1166 Golden Laced	1344 Rose Comb (Light Brown)
1072 White	1167 Partridge	1345 Rose Comb (Silver)
1081 Lamona- White	1168 Silver Laced	1346 Rose Comb (White)
1091 New Hampshire	1169 White	1347 Single Comb (Black)
Plymouth Rock	Langshan	1348 Single Comb (Black Tailed Red)
1101 Barred	1181 Black	1349 Single Comb (Buff)
1102 Blue	1182 Blue	1350 Single Comb (Columbian)
1103 Buff	1183 White	1351 Single Comb (Dark Brown)
1104 Columbia	ENGLISH	1352 Single Comb (Golden Duckwing)
1105 Partridge	1211 Australorp - Black	1353 Single Comb (Light Brown)
1106 Silver Penciled	Cornish	1354 Single Comb (Red)
1107 White	1221 Buff	1355 Single Comb (Silver)
1108 Brown Red	1222 Dark	1356 Single Comb (White)
1109 Weaten	1223 White	Leghorn
Rhode Island Red	1224 White Laced Red	1358 - Single Comb (Grey)
1111 Rose Comb	Dorking	1361 Minorca Rose Comb (Black)
1112 Single Comb	1231 Colored	1362 Rose Comb (White)
1121 Rose Comb	1232 Silver Grey	1363 Single Comb (Black)
Wyandolte	1233 White	
1131 Black	Orpington	
1132 Blue	1241 Black	
1133 Buff	1242 Blue	
1134 Columbia	1243 Buff	
1135 Golden Laced	1244 White	
1136 Partridge	1251 Redcap	
1137 Silver Laced		

The Great Stoneboro Fair

1364 Single Comb (Buff)	Faverolle	1554 - White
1365 Single Comb (White)	1471 -Salmon	Cubalaya
1371 Sicilian Buttercup	1472 - White	1561 - Black
1381 Spanish – White Faced	Houdan	1562 -Black Breasted Red
Black	1481- Mottled	1563 -White
	1482-White	Malay
CONTINENTAL (NORTH EUROPEAN)	1491 La Fleche – Black	1571 – Black
1401 Barnevelders		1572 - Black Breasted Red (Wheaten)
Campine	ALL OTHER STANDARD BREEDS (GAMES)	1573 - Red Pyle
1411 Golden	Modern Game	1574 - Spangled
1412 Silver	1511 – Birchen	1575 - White
Hamburg	1512 - Black	Phoenix
1421 Black	1513 - Black Breasted Red	1581 - Golden
1422 Golden-Penciled	1514 - Brown Red	1582 - Silver
1423 Golden Spangled	1515 - Golden Duckwing	Shamo
1424 Silver Penciled	1516 - Red Pyle	1591 - Black
1425 Silver Spangled	1517 - Silver Duckwing	1592 - Black Breasted Red (Wheaten)
1426 White	1518 - Wheaten	1593 - Dark
1431 Lakenvelder	1519 - White	1601 Sumatra – Black
1441 Welsummers	Old English Game	Yokohama
CONTINENTAL (POLISH)	1531 – Black	1611 - Red Shoulder
Polish	1532 - Black Breasted Red	1612 - White
1449- Bearded (Silver Laced)	1533 - Blue Breasted Red	ALL OTHER STANDARD BREEDS (MISCELLANEOUS)
1450 - Bearded (Buff Laced)	1534 - Blue Golden Duck-wing	Ameraucana
1451 – Bearded (Golden)	1535 - Blue Silver Duck wing	1621- Black
1452 – Bearded (Silver)	1536 - Brown Red	1622 - Blue
1453 – Bearded (White)	1537 - Golden Duckwing	1623 - Blue Wheaten
1454 – Non- Bearded (Buff Laced)	1538 - Lemon Blue	1624 - Brown Red
1455 – Non-Bearded (Golden)	1539 - Red Pyle	1625 - Buff
1456 – Non-Bearded (Silver)	1540 - Self Blue	1626 - Silver
1457 – Non-Bearded (White)	1541 - Silver Duckwing	1627 - Wheaten
1458 – Non-Bearded (White Crested Black)	1542 - Spangled	1628 - White
1459 – Non-Bearded (White Crested Blue)	1543 - White	Ameraucana
CONTINENTAL (FRENCH)	ALL OTHER STANDARD BREEDS (ORIENTALS)	1629 – Bircher
1461 Crevecoeur – Black	Aseel	1630 - Ginger Red
	1551 – Black Breasted Red (Wheaten)	1631 - Spangled
	1552 - Dark	Araucana
	1553 - Spangled	1641 – Black
		1642 - Black Red
		1643 - Golden Duckwing
		1644 - Silver Duckwing
		1645 - White
		Frizzle

The Great Stoneboro Fair

1651 – Clean Leg	2045 -Quail	Leghorn
1652 - Feather Leg	2046 - Red Pyle	2251 – Black
Naked Neck	2047 - Self Blue	2252 - Black Tailed Red
1661 – Black	2048 - Silver Duckwing	2253 - Buff
1662 - Buff	2049 - Spangled	2254 - Columbia
1663 - Red	2050 -Wheaten	2255 - Dark Brown
1664 - White	2051 - White	2256 - Golden Duckwing
Sultan1671 – White	2052 -Splash	2257 - Light Brown
1672 Appenzellow	2053 -Grey	2258 - Red
Spitzhauben		2259 - Silver
SECTION 2	SINGLE COMB CLEAN	2260 - White
BANTAM BREEDS AND	LEGGED	Minorca
VARIETIES	OTHER THAN GAME	2271 – Black
	BANTAMS	2272 - Buff
GAME BANTAMS	2111Ancona –Single Comb	2273 - White
Modern Game	2121 Andalusian - Blue	Naked Neck
2011 - Birchen	2131 Australorp - Black	2281 - Black
2012 - Black	Campine	2282 - Buff
2013 -Black Breasted Red	2141- Golden	2283 - Red
2014 - Blue	2142 - Silver	2284 - White
2015 - Blue Breasted Red	2151Catalana - Buff	2291 New Hampshire –
2016 - Brown Red	2161 Delaware – Single	Single Comb
2017 - Golden Duckwing	Comb	Orpington
2018 - Lemon Blue	Dorking	2301 – Black
2019 - Red Pyle	2171 – Colored	2302 - Blue
2020 - Silver Duckwing	2172 - Silver Grey	2303 - Buff
2021 - Wheaten	2181Frizzle – Clean Legged	2304 - White
2022 - White	Holland	Phoenix
Old English Game	2191 - Barred	2311 - Golden
2031 - Birchen	2192 - White	2312 - Silver
2032 - Black	Japanese	Plymouth Rock
2033 -Black Breasted	2201 – Black	2321 - Barred
Red	2202 - Black Tailed Buff	2322 - Black
2034 - Blue	2203 - Black Tailed White	2323 - Blue
2035 - Blue Breasted	2204 - Grey	2324 - Buff
Red	2205 - Mottled	2325 - Columbia
2036 - Blue Golden Duck-	2206 - White	2326 - Partridge
wing	2207 -Splash	2327 - Silver Penciled
2037 - Blue Silver Duck	Java	2328 - White
wing	2211 - Black	2331 Rhode Island Red –
2038 - Brassy Back	2212 - Mottled	Single Comb
2039 - Brown Red	Jersey Giant	2341Spanish – White Faced
2040 - Crele	2221 – Black	Black
2041 - Cuckoo	2222 - White	Sussex
2042 - Ginger Red	2231Lakenvelder- Single	2351 - Light
2043 - Golden Duckwing	Comb	2352 - Red
2044 - Lemon Blue	2241 Lamona – White	2353 - Speckled
		2354 - Coronation

The Great Stoneboro Fair

ROSE COMB CLEAN	Sebright	2682-Black Breasted Red
LEGGED BANTAMS	2531 - Golden	2683 - White
2411 Ancona - Rose Comb	2532 - Silver	Houdan
Antwerp Belgian	Wyandotte	2691 - Mottled
2421 - Black	2541 - Black	2692 - White
2422 - Blue	2542 - Blue	2701 La Fleche - Black
2423 - Cuckoo	2543 - Buff	Malay
2424 - Mille Fleur	2544 - Buff Columbian	2711 - Black Breasted
2425 - Mottled	2545 - Columbian	Red (Wheaten)
2426 - Porcelain	2546 - Golden Laced	2712 - Black
2427 - Quail	2547 - Partridge	2713 - Red Pyle
2428 - Self Blue	2548 - Silver Laced	2714 - Whitr
2429 - White	2549 - Silver Penciled	2715 - Spangled
2441 - Rose Comb	2550 - White	Polish
2451 Dorking - Rose Comb		2721 - Bearded (Buff
White		Laced)
Hamburg	ALL OTHER COMBS	2722 - Bearded (Golden)
2461 - Black	CLEAN LEGGED	2723 - Bearded (Silver)
2462 - Golden Penciled	BANTAMS	2724 - Bearded (White)
2463 - Golden Spangled	Ameraucana	2725 - Non Bearded (Buff
2464 - Silver Penciled	2611 - Black	Laced)
2465 - Silver Spangled	2612 - Blue	2726 - Non- Bearded
2466 - White	2613 - Blue Wheaten	(Golden)
Leghorn	2614 - Brown Red	2727 - Non-Bearded
2471 - Black Rose Comb	2615 - Buff	(Silver)
2472 - Buff Rose Comb	2615 - Silver	2728 - Non- Bearded
2473 - Dark Brown Rose	2617 - Wheaten	(White)
Comb	2618 - White	2729 - Non-Bearded
2474 - Light Brown Rose	Araucana	(White Crested Black)
Comb	2631 - Black	2730 - Non-Bearded
2475 - Silver Rose Comb	2632 - Black Red	(White Crested Blue)
2476 - White Rose Comb	2633 - Golden Duckwing	Shamo
Minorca	2636 - Silver Duckwing	2741 - Black
2481 - Black Rose Comb	2635 - White	2742 - Dark
2482 - White Rose Comb	2641 Buckeye- Pea Comb	2743 - Wheaten
2491 Redcap - Rose Comb	Chaniecler	2751 Sicilian Buttercup
2501 Rhode Island Red -	2651 - Partridge	2761 Sumatra - Black
Rose Comb	2652 - White	Yokohama
2511 Rhode Island White -	Cornish	2771 - Red Shouldered
Rose Comb	2661 - Blue Laced Red	2772 - White
Rosecomb	2662 - Buff	
2521 - Black	2663 - Dark	FEATHER LEGGED
2522 - Blue	2664 - White	BANTAMS
2523 - White	2665 - White Laced Red	Booted
2524 - Mottled	2671 Crevecoeur - Black	2811 - Bearded (Mille
2525 - Black Red	Cubulaya	Fleur)
2526 - Brown Red	2681 - Black	2812 -Bearded (Porcelain)
2527 - Lemon Blue		

The Great Stoneboro Fair

2813 - Bearded (White)	(Black)	Mallard
2814 - Non-Bearded (Mille Fleur)	2904 - Non-Bearded (White)	3171 - Grey
2815 - Non- Bearded (Porcelain)	2911 Sultan-White	3172 - Snowy
2816 - Non-Bearded (White)	2912 Mott Booted	GEESE- SECTION 4 HEAVY CLASS
D'ucelle Beard	DUCKS- SECTION 3 HEAVYWEIGHT CLASS	African
2817 - Blue	3011 Aylesbury - White	4011 - Brown
2818 - Mottled	Muscovy	4012 - White
2820 Booted Bearded – Brown Red	3021 - Blue	4021 Embden (Emden) - White
Brahma	3022 - Chocolate	Toulouse
2831 - Buff	3023 - Colored	4031 - Buff
2832 - Dark	3024 - White	4032 - Grey
2833 - Light	3031 Pekin - White	MEDIUM CLASS
Cochin	3041 Rouen	4041 American Buff- Buff
2841 – Barred	MEDIUMWEIGHT CLASS	4051 Pilgrim- Sex Linked
2842 - Birchen	3051 Buff - Buff	4061 Saddleback
2843 - Black	3061 Cayuga - Black	Pomeranian- Buff
2844 - Blue	Crested	4062 Saddleback
2845 - Brown Red	3071 - Black	Pomeranian- Grey
2846 - Buff	3072 - White	4071 Sebastopol - White
2847 - Columbian	3081 Swedish- Blue	LIGHT CLASS
2848 - Golden Laced	LIGHTWEIGHT CLASS	4081 Canada – Eastern (Common)
2849 - Mottled	3111 Campbell - Khaki	Chinese (China)
2850 - Partridge	Magpie	4091 - Brown
2851 - Red	3121 – Black & White	4092 - White
2852 - Silver Laced	3122 - Blue & White	4101 Egyptian – Colored (Brown)
2853 - White	Runner	4111 Tufted Roman - White
Faverolle	3131 – Black	GUINEA FOWL- SECTION 5
2861 - Salmon	3132 - Buff	5011 Pearl
2862 - White	3133 -Chocolate	5022 <u>White</u>
Frizzle	3134 -Cumberland Blue	5012 Lavender
2871 – Feather Legged	3135 -Fawn & White	5013 Coral Blue
2872 - Black	3136 - Grey	5014 Buff Dundotte
2873 - White	3137 - Penciled	SECTION 8 TURKEYS
2874 - Blue	3138 - White	6001 Bronze
Langshan	BANTAM (DUCK) CLASS	6002 White
2881 – Black	Call	6003 Blue Slate
2882 - Blue	3151 - Blue	6004 Royal Palm
2883 - White	3152 - Grey	6005 Bourban Red
Silkie	3153 - Snowy	6006 Holland
2900 – Bearded (Red)	3154 - White	6007 Buff
2901 – Bearded (Black)	3161 East India – Black	6008 Black
2902 - Bearded (White)		6009 Narragensett
2903 - Non-Bearded		

The Great Stoneboro Fair

SECTION 1 Chickens

Class

1. Cock, hatched before

January 1, 2024\$5.00 \$4.00 \$3.00

2. Hen, hatched before

January 1, 2024\$5.00 \$4.00 \$3.00

3. Cockerel, hatched after

January 1, 2024\$5.00 \$4.00 \$3.00

4. Pullet hatched after

January 1, 2024\$5.00 \$4.00 \$3.00

SECTION 2 Bantams

Class

1. Cock, hatched

before January 1, 2024..... \$5.00 \$4.00 \$3.00

2. Hen, hatched

before January 1, 2024..... \$5.00 \$4.00 \$3.00

3. Cockerel, hatched

after January 1, 2024..... \$5.00 \$4.00 \$3.00

4. Pullet, hatched

after January 1, 2024..... \$5.00 \$4.00 \$3.00

SECTION 3 Ducks

Class

1. Male, hatched before January 1, 2024.....\$5.00 \$4.00 \$3.00

2. Female, hatched before January 1, 2024\$5.00 \$4.00 \$3.00

3. Male, hatched after January 1, 2024\$5.00 \$4.00 \$3.00

Female, hatched after January 1, 2024\$5.00 \$4.00 \$3.00

SECTION 4 Geese/Turkeys

Class

1. Male, hatched before

January 1, 2024\$5.00 \$4.00 \$3.00

2. Female, hatched before

January 1, 2024\$5.00 \$4.00 \$3.00

3. Male, hatched after

January 1, 2024\$5.00 \$4.00 \$3.00

4. Female, hatched after

January 1, 2024\$5.00 \$4.00 \$3.00

SECTION 5 Guinea Fowl

Class

1. Cock, hatched before

January 1, 2024\$5.00 \$4.00 \$3.00

2. Hen, hatched before

January 1, 2023\$5.00 \$4.00 \$3.00

The Great Stoneboro Fair

- 3. Cock, hatched after
January 1, 2024 \$5.00 \$4.00 \$3.00
- 4. Hen, hatched after
January 1, 2024 \$5.00 \$4.00 \$3.00

SECTION 6

Grand Champion Over all Breeds

Class

- 1. Best Male Bantam \$5.00
- 2. Best Female Bantam \$5.00
- 3. Best Large Male Fowl \$5.00
- 4. Best Large Female Fowl \$5.00
- 5. Best Goose \$5.00
- 6. Best Duck \$5.00
- 7. Best Turkey \$5.00
- 8. Best Guinea \$5.00

SECTION 7

EGGS

Exhibit shall consist of one dozen eggs, to be judged on freshness, condition of shell, size, color, and shape.

PREMIUMS..... \$4.00 \$3.00 \$2.00

Class

- 1. Best dozen of eggs (white) 22-24 oz. medium
- 2. Best dozen of eggs (white) 24-26 oz. large
- 3. Best dozen of eggs (white) over 27 oz. ex. large
- 4. Best dozen of eggs (brown) 22-24 oz. medium
- 5. Best dozen of eggs (brown) 24-26 oz. large
- 6. Best dozen of eggs (brown) over 27 oz. ex. large
- 7. Any other

**Feed Donated by:
McCartney's Feed Mill and Hardware, Sandy
Lake Mills
Tractor Supply - Greenville**



2024 Stoneboro Fair Jr. Fair Board

Derek Beach – Advisor

Makenna Saeler • Jordan Olson • Aidan Black • Aaron Straub • Cheyanne Minor

DEPARTMENT 9 - RABBITS

Superintendent: Zoe Pizor (724) 856-2059

Assistant: Morgan Powers (814) 516-5962

The Rabbit Show is August 28, 2024 at 10AM. Entry deadline is August 7, 2024. Cage space is limited and will be assigned in the order the entries are received. No Exhibitor can enter more than 15 Rabbits. Additional entries will be accepted after August 7th if cage space is available. All Rabbits entered must be housed. All Rabbits entered must be shown. The Stoneboro Fair reserves the right to refuse entries without cause.

Rabbit Exhibit and Show Rules

1. This is an Open Sanctioned A.R.B.A. Show.
2. The Rabbit Show will be governed by the most current A.R.B.A. Standards.
3. All Stoneboro Fair Rules and Regulations will be followed.
4. The Stoneboro Fair is not responsible for fire, theft, or accidents.
5. The Stoneboro Fair reserves the right to substitute Judges.
6. No class will be re-judged. The Judge's decision is final.
7. All Rabbits **MUST** have a permanent left ear tattoo #.
8. Diseased or Sick Rabbits will be refused entry and/or removed from the Rabbit Exhibit.
9. All Rabbits will be visually health-checked upon admittance.
10. Please include Breed, Class, Section # (Group/Variety), Sex, and Ear # on entry form. **NO RABBIT CAN BE SUBSTITUTED FOR ANOTHER RABBIT ON ENTRY DAY.**
11. All Rabbits must remain on display until 7:00 PM the last day of the Fair and removed by 9:00 PM.
12. All Rabbits entered must be housed and shown.
13. Exhibitors may **ONLY** place or remove **THEIR OWN** Rabbits from the show table during the show. **RUNNERS** will place and remove the **REMAINING** Rabbits from the show table.
14. All Rabbits must be entered Tuesday, August 27, 2024 between 12:00 Noon and 7:00 PM.
15. **ALL SCRATCHES MUST BE MADE TO ZOE PIZOR BY PHONE: (724) 856-2059 by Monday, August 26, 2024. Thank You.**

ALL ANIMAL ENTRIES ARE REQUIRED TO MEET THE 2024 PENNSYLVANIA DEPARTMENT OF AGRICULTURE ANIMAL HEALTH REQUIREMENTS AND RECOMMENDATIONS FOR ANIMALS FOR EXHIBITION AS LISTED IN THE BACK OF YOUR PREMIUM BOOK. ALL HORSES ALSO REQUIRE RABIES SHOTS

The Great Stoneboro Fair

Rabbit Exhibit Building Rules

1. All "FOR SALE" signs will be supplied by the Fair and placed on the cages after the show. NO STICKERS.
2. Feed and water bowls are provided. Feeding and watering is available. The Fair will water twice daily. If you choose to feed and water your own Rabbits, you must feed and water daily. The Fair cannot accommodate special diets.
3. If you choose to feed your Rabbits hay, please remove all excess hay from the cages the last day of the Fair.
4. All Rabbits must remain on display until 7 PM the last day of the Fair and be removed by 9 PM.
5. Rabbits which are sold during the Fair CANNOT be removed before 7 PM the last day of the Fair.
6. All personal items must be removed from the Rabbit exhibit daily.
7. Rabbits must be displayed only in the assigned area.
8. Exhibitors may drive in on entry day, show day, and through the designated gate after 7PM on the last day of the Fair to pick up their Rabbits.

CLASSES

Senior Buck
Senior Doe

Junior Buck
Junior Doe

6/8 Buck
6/8 Doe

ENTRY FEE \$1.00 per RABBIT

Premiums

Premiums will be paid to Exhibitors whose Rabbits are housed all week.

1st - \$4.00 2nd - \$3.00 3rd - \$2.00

Trophies for Grand Champion and Reserve Champion

Rosettes for BOB and BOSB

FEED & SHAVINGS DONATED BY:

GROVE CITY AGWAY

American	008-Colored	016-White
001-Blue	009-White	Brittania Petite
002-White	Angora-Giant	000-Broken
Am. Fuzzy Lop	010-R.E.W.	017-Black
003-Broken	Angora-Satin	018-Black Otter
004-Solid	011-Colored	019-Chestnut
Am. Sable – 005	024-White	200-Siamese Sable
Angora-English	Belgian Hare – 013	201-Himalayan
006-Colored	182-Rufus	202-Tortise
007-White	183-Tan	Agouti
Angora-French	Bevern	020-R.E.W.
	014-Black	988-B.E.W
	015-Blue	021-Sable Marten
		Californian - 022

The Great Stoneboro Fair

Champagne	Shaded	Shaded
D'Argent – 024	0661-Blue Tortoise	0910-Silver
Chinchilla Am. – 026	0662-Sable Point	0921-Sable Point
Chinchilla Giant – 027	0663-Seal	0922-Siamese Sable
Chinchilla Std. – 028	0664-Siamese Sable	0923-Siamese Sm. Pearl
Cinnamon – 029	0665-Smoke Pearl	0924-Tortoise
Crème D'Argent – 030	0666-Tortoise	0925-Blue Tort.
Dutch	Tan Pattern	Agouti
031-Black	0671-Black Otter	0931-Chestnut
032-Blue	0672-Blue Otter	0932-Chinchilla
033-Chocolate	0673-Sable Marten	0933-Lynx
034-Gray	0674-Silver Marten	0934-Opal
035-Steel	0675-Sm. Pearl Marten	0935-Squirrel
036-Tortoise	Lilac - 068	Tan Pattern
037-Chinchilla	Mini Rex	0941-Otter
Florida White – 052	077-Black	0942-Sable Marten
Harlequin	078-Blue	0943-Silver Marten
053-Japanese	079-Broken	0944-Sm. Pearl Marten
054-Magpie	080-Castor	0945-Tans
Havana	081-Chinchilla	AOV
055-Black	082-Chocolate	0951-Fawn
056-Blue	083-Himalayan	0952-Himalayan
057-Chocolate	084-Lilac	0953-Orange
063-Broken	085-Lynx	0954-Steel
012-Lilac	086-Opal	0955-Broken
Himalayan	087-Red	Dwarf Hotot
058-Black	088-Seal	037-Black
059-Blue	089-Tortoise	062-Chocolate
060-Chocolate	090-White	206-Blue
061-Lilac	091-Sable Point	English Spot
Blanc de Hotot – 981	092-Blue Eyed White	038-Black
Jersey Wooly	093-Otter	039-Blue
636-Tortoise	094-Silver Marten	040-Chocolate
Agouti	203-Sable Marten	041-Gold
0631-Chestnut	204-Smoke Pearl Marten	042-Grey
0632-Chinchilla	0900-Tricolor	043-Lilac
0633-Opal	0982-Smoke Pearl	044-Tortoise
0634-Squirrel	Netherland Dwarf Self	Flemish Giant
0635-Broken	214-Shadow Lutino	045-Black
AOV	215-Orange Lutino	046-Blue
0641-Pointed White	0911-Black	047-Fawn
Self	0912-Blue	048-Lt. Gray
0651-Black	0913-Chocolate	049-Sandy
0652-Blue	0914-Lilac	050-Steel Gray
0653-B.E.W.	0915-B.E.W.	051-White
0654-Chocolate	0916-R.E.W.	Lop-English
0655-Lilac		069-Broken
0656-R.E.W.		025-Czech Frost
		070-Solid

The Great Stoneboro Fair

Lop-French	Checked Giant	Lionhead
071-Broken	212-Black	150-Sable Point
072-Solid	213-Blue	151-Chestnut
Lop-Holland	Blue Holicer - 216	152-Siamese Sable
073-Broken	Rhineland	153-Black Tort.
074-Solid	121-Black	154-R.E.W.
Lop-Mini	165-Blue	155-White Point
075-Broken	Satin	156-Tan
076-Solid	122-Black	157-Solid Tort.
New Zealand	123-Blue	176-Blue Tort.
096-Black	124-Broken	177-Chocolate Tort.
097-Red	125-Californian	178-Lilac Tort.
098-White	126-Chinchilla	205-Smoke Pearl
0980-Broken	127-Chocolate	984-Chocolate
990-Blue	128-Copper	985-Seal
Palimino – 099	129-Red	Mini Satin
207 Golden	130-Siamese	160-White
208 Lynx	131-White	161-Chinchilla
Polish	158-Smoke Pearl	162-Opal
100-Black	181-Otter	163-Red
101-Blue	Silver	164-Siamese
102-Broken	132-Black	165-Black
103-Chocolate	133-Brown	166-Chocolate
104-B.E.W.	134-Fawn	167-Otter
105-R.E.W.	135-Silver Fox	168-Blue
179-Lilac Polish	Silver Fox	169-Tortoise
Rex	130-Blue	170-Silver Marten
106-Black	136-Black	171-Himalayan
107-Black Otter	209-Chocolate	172-Chocolate Agouti
108-Blue	Silver Marten	173-Squirrel
109-Broken	140-Black	174-Broken
110-Californian	141-Blue	986-Copper
111-Castor	142-Chocolate	987-Lilac
112-Chinchilla	143-Sable	Thrianta – 175
113-Chocolate	Tan	Argente Brum. – 983
114-Lilac	144-Black	Dwarf Papillion – 989
115-Lynx	145-Blue	210-Black
116-Opal	146-Chocolate	211-Blue
117-Red	147-Lilac	218-Chocolate
118-Sable		
119-Seal		
120-White		
156-Amber		

OFFICIAL AMERICAN RABBIT BREEDERS ASSOCIATION SANCTIONED SHOW: P.O. BOX 400, KNOX, PA 16232-0400; WWW.ARBA.NET (814) 297-8233 MEMBERSHIP DUES: ADULT: \$20.00 PER YEAR, 3 YEARS \$50.00:

YOUTH: \$12.00 PER YEAR, 3 YEARS \$30.00: COMBINATION HUSBAND/WIFE: \$30.00 PER YEAR, 3 YEARS \$75.00: SINGLE ADULT FAMILY: \$20.00 PLUS \$5.00 PER YOUTH PER YEAR, 3 YEARS \$50.00 PLUS \$10.00 PER YOUTH HUSBAND/WIFE FAMILY: \$30.00 PLUS \$5.00 PER YOUTH PER YEAR, 3 YEARS \$75.00. PLUS \$10.00 PER YOUTH

DEPARTMENT 101

4-H and VOCATIONAL HORSES

SECTION A-1-1 DRAFT HORSES

- A. Belgian
- B. Percheron
- C. Haflinger
- D. Other Draft (enter only if breed is not listed)
- E. Grade Draft Pony
- F. Mule

The following classes will apply to members of the 4-H Club organized under supervision of the Penn State University Extension Service and its County Agents or members of the F.F.A. Those members who are enrolled in a full time Department of Vocational Agriculture at the date of the current Fair must be in good standing. These members must be present and have charge of their animals at the time of the judging. All animals must be in the Exhibitor's name and shown by a YOUTH. Refer to General Rules and Regulations in Section 1, Department 1.

ALL ANIMAL ENTRIES ARE REQUIRED TO MEET THE 2024 PENNSYLVANIA DEPARTMENT OF AGRICULTURE ANIMAL HEALTH REQUIREMENTS AND RECOMMENDATIONS FOR ANIMALS FOR EXHIBITION AS LISTED IN THE BACK OF YOUR PREMIUM BOOK. **ALL HORSES ALSO REQUIRE RABIES SHOTS**

1. Stallion Foal	\$10	\$8	\$5	\$3
2. Gelding 4 and over.....	\$20	\$15	\$10	\$8
3. Gelding under 4	\$20	\$15	\$10	\$8
4. All Breed Champion & Reserve Gelding (Rosette Only)				
5. Mare 4 and over.....	\$20	\$15	\$10	\$8
6. Mare under 4	\$20	\$15	\$10	\$8
7. All Breed Champion and Reserve Mare (Rosette Only)				
8. Filly Foal.....	\$10	\$8	\$5	\$3

SECTION A-1-2 LIGHT HORSES (Over 56")

- A. Arabian
- B. Saddlebred
- C. Morgan
- D. Quarter Horse
- E. Paint
- F. Other Breed (enter only if breed is not listed)

1. Stallion Foal	\$10	\$8	\$5	\$3
2. Gelding 4 years and over.....	\$15	\$12	\$10	\$8
3. Gelding under 4.....	\$15	\$12	\$10	\$8
4. All Breed Champion & Reserve Gelding (Rosette Only)				
5. Mare 4 and over.....	\$15	\$12	\$10	\$8
6. Mare under 4.....	\$15	\$12	\$10	\$8
7. All Breed Reserve Champion Mare (Rosette Only)				
8. Filly Foal.....	\$10	\$8	\$5	\$3

The Great Stoneboro Fair

SECTION A-1-3 PONIES & MINIATURE HORSES

- A. Miniature Horse (38" or under)
 - B. Pony (under 56")
 - C. Burro
1. Stallion Foal\$10 \$8 \$5 \$3
 2. Gelding 4 years and over\$15 \$12 \$10 \$8
 3. Gelding under 4\$15 \$12 \$10 \$8
 4. Mare 4 and over\$15 \$12 \$10 \$8
 5. Mare under 4\$15 \$12 \$10 \$8
 6. Filly Foal\$10 \$8 \$5 \$3
 7. Grand Champion Mare (Rosette)
 8. Reserve Grand Champion Mare (Rosette)
 9. Grand Champion Gelding (Rosette)
 10. Reserve Grand Champion Gelding (Rosette)

SECTION A-1-4 GROOMING AND SHOWMANSHIP

1. Exhibitors 8 years old and under\$8 \$7 \$6 \$5
2. Exhibitors 9, 10, 11, 12, 13 years old\$8 \$7 \$6 \$5
3. Exhibitors 14, 15, 16, 17, 18 years old\$8 \$7 \$6 \$5

Check out Music at
Bedford Grange Mutual Insurance
Centerfield Pavilion



***Enjoy some good music
and picnic table seating!***

Show Times and Groups
Listed in Fair Schedule

DEPARTMENT 102
4-H and VOCATIONAL
SECTION A-2 Dairy Cattle

Breeds: A - Ayrshire
 H - Holstein

B - Brown Swiss
 J - Jersey

G - Guernsey
 M - Milking Shorthorn

ALL ANIMAL ENTRIES ARE REQUIRED TO MEET THE 2024 PENNSYLVANIA DEPARTMENT OF AGRICULTURE ANIMAL HEALTH REQUIREMENTS AND RECOMMENDATIONS FOR ANIMALS FOR EXHIBITION AS LISTED IN THE BACK OF YOUR PREMIUM BOOK. **ALL HORSES ALSO REQUIRE RABIES SHOTS**

(Refer to General Rules and to Rules and Regulations in Section 1.)

The following classes will apply to members of the 4-H Club organized under supervision of the Penn State University Extension Service and its County Agents or members of the F.F.A. These members who are enrolled in a full time Department of Vocational Agriculture at the date of the current Fair must be in good standing. These members must be present and have charge of their animals at the time of the judging. Each member will be allowed to show two animals per class and a total of 5 per Exhibitor. All animals must be in the Exhibitor's name and shown by a YOUTH.

1. Junior 2 Year Old born between Mar. 1, 2022 and Aug. 31, 2022	\$25	\$20	\$15	\$12
2. Senior 2 Year Old born between Sept. 1, 2022 and Feb. 28, 2022	\$25	\$20	\$15	\$12
3. Junior 3 Year Old born between Mar. 1, 2020 and Aug. 31, 2021	\$25	\$20	\$15	\$12
4. Senior 3 Year Old born between Sept. 1, 2020 and Feb. 28, 2021	\$25	\$20	\$15	\$12
5. Dry Cow, 3 and 4 Years Old, born between Sept.1, 2019 and Aug. 31, 2020.....	\$25	\$20	\$15	\$12
6. Dry Cow, 5 years old and over, born before Sept. 1, 2010.....	\$25	\$20	\$15	\$12
7. 4 Year Old Cow in Milk, born between Sept. 1, 2019 and Aug. 31, 2020.....	\$25	\$20	\$15	\$12
8. 5 Year Old Cow in Milk, born before Sept. 1, 2019.....	\$25	\$20	\$15	\$12
9. 6 Year Old and over Cow in Milk, born before Sept. 1, 2018.....	\$25	\$20	\$15	\$12
10. Senior Champion Female	Rosette			
11. Reserve Senior Champion Female	Rosette			
20. Junior Heifer Calf born between Mar. 1, 2023 and May 31, 2024.....	\$14	\$12	\$9	\$6
21. Intermediate Heifer Calf born between Dec. 1, 2023 and Feb. 28, 2024	\$14	\$12	\$9	\$6
22. Senior Heifer Calf born between Sept. 1, 2023 and Nov. 30, 2024.....	\$14	\$12	\$9	\$6
23. Summer Yearling Calf born between June 1, 2023 and Aug. 31, 2024	\$18	\$15	\$10	\$8

The Great Stoneboro Fair

- 24. Spring (Jr.) Yearling Heifer born between
Mar. 1, 2024 and May 31, 2024.....\$18 \$15 \$10 \$8
- 25. Winter (Int.) Yearling Heifer born between
Dec. 1, 2023 and Feb. 28, 2024.....\$18 \$15 \$10 \$8
- 26. Fall (Sr.) Yearling Heifer born between
Sept. 1, 2023 and Nov. 30, 2023\$18 \$15 \$10 \$8
- 27. Junior Champion Female Rosette
- 28. Reserve Junior Champion Female Rosette
- 31. Grand Champion Female Rosette
- 32. Reserve Grand Champion Female Rosette
- 35. Dam and Daughter (Dam must be owned by Exhibitor; Daughter must be
"bred and owned" by Exhibitor).\$30 \$25 \$20 \$15
- 36. Best Bred and Owned. Banner
- 37. Champion Dairy and Showmanship Award - Jr. Courtesy of
Book Family Seed Sales
- 38. Champion Dairy and Showmanship Award - Int. Courtesy of
Book Family Seed Sales
- 39. Champion Dairy and Showmanship Award - Sr. Courtesy of McCartney's
Feed Mill & Hardware

***Thank You
to the
Stoneboro Fair
Advertisers***

DEPARTMENT 103

4-H and VOCATIONAL BEEF CATTLE

Section 1 – Breeding Animals

When on exhibit in the ring, each animal must be under halter and in the charge of owner or owner's representative.

NOTE: Classifications and premiums listed are to apply to each of these breeds.

A – Angus	H – Hereford
C – Charolais	S – Shorthorn
SI – Simmental	O – Others
OC – Crossbreed	OL – Limousin

- | | | | | | |
|----|--|------|------|------|-----|
| 1. | Heifer Calf calved after Sept. 1, 2023..... | \$16 | \$12 | \$9 | \$6 |
| 2. | Summer Yearling Heifer calved between May 1 and Aug. 31, 2022.... | \$16 | \$12 | \$9 | \$6 |
| 3. | Junior Yearling Heifer calved between Jan. 1 and Apr. 30, 2023..... | \$18 | \$12 | \$10 | \$8 |
| 4. | Senior Yearling Heifer calved between Sept. 1 and Dec. 31, 2022.... | \$18 | \$12 | \$10 | \$8 |
| 5. | Champion Female (first place female competing).....Rosette & \$25 courtesy of Ligo General Contracting | | | | |
| 6. | Reserve Champion Female (first place Females and second place to champion).....Rosette & \$25 courtesy of Ligo General Contracting | | | | |
| 7. | Showmanship & Grooming Exhibitors 8 years & under..... | \$15 | \$10 | \$5 | \$5 |
| 8. | Showmanship & Grooming 9, 10, 11, 12, and 13 year olds..... | \$15 | \$10 | \$5 | \$5 |
| 9. | Showmanship & Grooming 14, 15, 16, 17, and 18 year olds..... | \$15 | \$10 | \$5 | \$5 |

SECTION 2

4-H and FFA Steers

Breeds must be designated on Entry Blank.

- | | | | | | |
|----|-------------------------------------|------|------|------|-----|
| 1. | Light Weight – Under 900 lbs..... | \$17 | \$12 | \$10 | \$8 |
| 2. | Medium Weight – 900 – 1100 lbs..... | \$17 | \$12 | \$10 | \$8 |
| 3. | Heavy Weight – Over 1100 lbs..... | \$17 | \$12 | \$10 | \$8 |
| 4. | Breed Champion.....Ribbon | | | | |
| 5. | Grand Champion Steer.....Rosette | | | | |

Please Note:

1. Rules 1 and 2 in Open Class Market Steers apply in this class.
2. No Exhibitors may enter two in 4-H and two in F.F.A. unless they are separate projects.
3. Crossbred Steers show in breed of Sire.

DEPARTMENT 104

SECTION 1

JUNIOR SHEEP BREEDING - YOUTH EXHIBIT

Junior Sheep Breeding - Youth Exhibit 4-H and Vocational

To be eligible for premiums, Exhibitors must be members of the 4-H Club, organized under supervision of the Penn State University Extension Service and its County Agents and must be a F.F.A. member in good standing who is enrolled in a full-time Department of Vocational Agriculture at date of the current Fair, and must be present and have charge of his/her animals at the time of judging. Each member will be allowed to show two (2) animals per class. Member should provide a letter of verification at the time of entry from their County Agent or Agriculture Teacher. This letter must accompany entry blank as to ownership. Registration papers must show Junior member's ownership and will be checked at time of entry. **Send a duplication registration paper with entry for each animal.** Animals shown in Market classes are not eligible for Breeding classes, and animals entered in Breeding classes are not eligible for Market classes.

Class

1. Ram, 1 year and under 2
2. Ram Lamb, under 1 year
3. Two Ram Lambs
4. Champion Ram
5. Reserve Champion Ram
6. Ewe, 1 year and under 2
7. Pair of Yearling Ewes
8. Ewe Lamb, under 1 year
9. Two Ewe Lambs
10. Champion Ewe
11. Reserve Champion Ewe
12. Pen of Lambs (2 Rams, 2 Ewes, one entry)
13. Breeder's young flock (Ram Lamb and 2 Ewe Lambs, bred and owned by Exhibitor)
14. Get-of-Sire (four breeding animals any Age or Sex, by one sire; need not be owned by one Exhibitor; one entry)
15. Flock (1 Ram, 2 yearling Ewes and 2 Ewe Lambs; one entry)
16. Supreme Junior Champion Ram
17. Supreme Junior Champion Ewe
18. Bred and Owned

PREMIUMS \$10 \$8 \$6 \$5

Awards: \$50 Supreme Champion Ewe - Jr. Show -
sponsored by Ligo General Contracting.

The Great Stoneboro Fair

A. Cheviot	I. Columbia	ND. Debouillet
B. Corriedale	J. Rambouillet	NH. Horned Dorset
C. Dorset	K. Oxford	NL. Lincoln
D. Hampshire	L. Montadale	NN. Natural Color
E. Shropshire	M. Tunis	NP. Polypay
F. Southdown	NR. Romney	
G. Suffolk	NA. Arcott	NT. Targnee
H. Merino	NB. Border Liecester	NV. Romanov

SECTION A1-2 4-H JUNIOR MARKET LAMBS

1. Light Weight: 85-100 pounds
 2. Medium Weight: 101-120 pounds
 3. Heavy Weight: 121-140 pounds
 4. Pair of Lambs (any weight class, Wethers or Ewes)
 5. Pen of Market Lambs (3 lambs, can be Wethers or Ewes)
 6. Champion Market Lamb Rosette
 7. Reserve Champion Market Lamb Rosette
- PREMIUMS:..... \$10 \$8 \$6 \$5

SECTION A1-3 JUNIOR SHOWMANSHIP

1. Ages 9-11..... \$15 \$10 \$5 \$5
2. Ages 12-15..... \$15 \$10 \$5 \$5
3. Ages 16-18..... \$15 \$10 \$5 \$5

Only Exhibitors with Sheep entries are eligible to compete for showmanship premiums. Juniors will be permitted to show any animal they have entered, with no restriction on Age or Sex of the animal. Juniors will be judged only on showmanship skills (not grooming).



DEPARTMENT 106

4-H AND VOCATIONAL GOATS

The following class will apply to members of the 4-H Club organized under supervision of the Penn State University Extension Service and its County Agents or members of the F.F.A. These members who are enrolled in a full time Department of Vocational Agriculture at the date of the current Fair must be in good standing. These members must be present and have charge of their animals at the time of the judging. Each member will be allowed to show two animals per class. All animals must be in the Exhibitor's name and shown by a YOUTH.

ALL ANIMAL ENTRIES ARE REQUIRED TO MEET THE 2024 PENNSYLVANIA DEPARTMENT OF AGRICULTURE ANIMAL HEALTH REQUIREMENTS AND RECOMMENDATIONS FOR ANIMALS FOR EXHIBITION AS LISTED IN THE BACK OF YOUR PREMIUM BOOK. **ALL HORSES ALSO REQUIRE RABIES SHOTS**

- BREEDS:
- | | | |
|-----------|--------------------|-------------------|
| A. Alpine | D. Toggenburg | G. Oberhasli |
| B. Nubian | E. Recorded Grades | H. Boer |
| C. Saanen | F. LaMancha | I. Nigerian Dwarf |
| | | J. Mytonic |

SECTION 1 Dairy Goats

PREMIUMS	\$10	\$8	\$6	\$5
Class				

1. Kid Doe under 5 months
2. Kid Doe 5 months old & under one year
3. Doe 1 year old and under 2 not in milk
4. Junior Champion Doe—Ribbon Only
5. Reserve Junior Champion Doe—Ribbon Only
6. Doe 1 year old and under 2 in milk
7. Doe 2 years old and under 3 years
8. Doe 3 years old and under 6 years
9. Doe 6 years old and over—Ribbon Only
10. Senior Champion Doe—Ribbon Only
11. Reserve Senior Champion Doe—Ribbon Only
12. Grand Champion Doe—Rosette - \$50 award courtesy of Lou Ann Miller CPA
13. Reserve Grand Champion Doe—Rosette

Classes 14—19 will be judged by breed. At the end of the last breed, each 1st place winner of the following classes will return to the ring to pick the Best of Show in each of the following classes. The Best of Show will receive a Special Award, Trophy, or Ribbon. Each Exhibitor may enter one animal per breed for each class.

14. Get of Sire
15. Produce of Dam
16. Dam and Daughter
17. Milking Herd (Limited to 3 animals)
18. Best udder in show
19. Best Doe bred by Exhibitor
20. Best Doe in show picked from Grand Champion of each breed
21. Best Junior Champion Doe

The Great Stoneboro Fair

SECTION 2 OPEN CLASS MARKET GOATS

Premiums \$10 \$8 \$6 \$5

1. Light Weight Market Goat
 2. Medium Weight Market Goat
 3. Heavy Weight Market Goat
 4. Grand Champion Market Goat - Ribbon or Rosette \$50 awarded courtesy of Lou Ann Miller CPA
 5. Reserve Champion Market Goat - Ribbon or Rosette
- Market classes can be wethers and/or does. Does shown in market classes are not eligible for breeding classes

SECTION 3 SHOWMANSHIP

- | | 1st-\$10 | 2nd-\$8 | 3rd-\$6 | 4th-\$5 |
|------------------------|----------|---------|---------|---------|
| 1. Ages 9, 10, 11 | | | | |
| 2. Ages 12, 13, 14, 15 | | | | |
| 3. Ages 16,17,18 | | | | |

Youth will be judged only on showmanship skills and will be permitted to use any animal they have entered in either Breeding or Market classes.

DEPARTMENT 109

4-H RABBITS

To be eligible for premiums, all Exhibitors must be a member of a Mercer County 4-H Club and be in good standing under the supervision of the Penn State University Extension Services and County Agents.

The Rabbit Show is August 28, 2024, at 10:00 AM. The Entry Deadline is August 21, 2024. Cage space is limited and will be assigned in the order entries are received. All Rabbits entered must be housed. All Rabbits entered must be shown. Refer to Department 9 Rabbits for all Exhibitor and Show Rules.

Additional 4-H Exhibit and Show Rules

1. Use a 4-H Entry form to enter your 4-H Rabbit entries.
2. All 4-H Rabbit entries must also be entered in the Open Sanctioned Rabbit Show. Use the Animal Entry Form to enter your Rabbits for the Open Sanctioned Show.
3. All Rabbits MUST have a permanent left ear tattoo #.
4. Please include Breed, Class, Section# (Group/Variety), Sex and Ear# on entry forms.

CLASSES

Senior Buck	Junior Buck	6/8 Buck
Senior Doe	Junior Doe	6/8 Doe

Premiums

Premiums will be paid to Exhibitors whose Rabbits are housed all week.

1st - \$4.00	2nd - \$3.00	3rd - \$2.00
--------------	--------------	--------------

DEPARTMENT 11

YOUTH

1. Open to Youth under the age of 18. For any categories not listed, you may enter in open class.

ALL Exhibitors MUST provide their OWN PLATES
for exhibition in **EACH** category

SECTION ONE

All products must have been made by the Exhibitor. Each Exhibitor may enter one article in each division of a class.

Class

-Baked Bread and Rolls.....	\$3.50	\$3.00	\$2.50
1. Bread, White 1 loaf		4. Rolls, dinner (5)	
2. Bread, Whole Wheat		5. Pretzels (5)	
3. Cinnamon Rolls (5)			
-Treats	\$3.00	\$2.50	\$2.00
7. Trail Mix (1/2 cup)		9. Other Fudge (5)	
8. Chocolate Fudge			
-Cookies (5)	\$3.00	\$2.50	\$2.00
11. Brownies		15. Rolled	
12. Chocolate Chip		16. Cereal Squares	
13. Oatmeal		17. Other Dropped	
14. Peanut Butter		18. Bar Cookies	
-Cakes- Frosted & Unfrosted	\$3.50	\$3.00	\$2.00
21. Chocolate		22. White/Yellow	
23. Gluten Free		25. Butter	
-Egg Cakes - Not Iced			
24. Angel		26. Sponge	
-Cup Cakes (4).....	\$3.00	\$2.50	\$2.00
27. Chocolate		28. White	
-Pies.....	\$3.50	\$3.00	\$2.00
29. One crust pie, any kind (no cream or custard)			
30. Two crust pie			
-Canned Fruits (pints or quarts)	\$1.50	\$1.25	\$1.00
31. Peaches		33. Applesauce	
32. Pears		34. Other	
-Canned Vegetables (pint or quart).....	\$1.50	\$1.25	\$1.00
35. Beans, any variety		41. Spaghetti Sauce	
36. Beets		42. Other	
37. Carrots			
38. Corn			
39. Peas			
40. Tomatoes			
-Pickles/Relish (pint or quart).....	\$1.50	\$1.25	\$1.00
43. Sweet			
44. Dill			
45. Bread & Butter			
46. Relish - any variety			

THANK YOU!

Mijavec's

*Auction Winner of the 2023 Great Stoneboro Fair
Blue Ribbon Apple Pie Contest
Baked by Ace Buchanan*



*Your Support of the 2023 Baked Goods' Auction
was greatly appreciated.*

**Join Us This Year at 6:00 PM, Thursday, August 29th, 2024
for the 2024 Baked Goods Auction in the Ibbs Building.**

The Great Stoneboro Fair

SECTION 2 Sewing

Each article must have been made since the 2023 Fair by a Youth under the age of 18.

Class

1. Apron	\$2.50	\$2.00	\$1.50
2. Tote or Gym Bag			
3. Accessories - 3 or more			
4. Potholders or Mitt			
5. Pants, Shorts or Skirt with elastic or drawstring			
6. Shirt, Top or Blouse with casing or simple closure			
7. Pillow or Quillo			
8. Draft Dodger			
9. Doll Clothes			
10. Quilted Item			
-Coordinates	\$3.50	\$3.00	\$2.00
14. Top, Vest or Poncho and Skirt with waistband or facing			
15. Top, Vest or Poncho and Pants or Shorts with waistband or facing			
16. Dress			
17. Tailored Jacket or Sport Coat.....	\$4.00	\$3.00	\$2.00
18. Tailored ensemble.....	\$ 5.00	\$4.00	\$3.00
19. Special occasion garment	\$4.00	\$3.00	\$2.00
20. Useful articles (Kitchen)	\$2.50	\$2.00	\$1.50
21. Useful articles (Other)	\$2.50	\$2.00	\$1.50

SECTION 3

Knitting, Crocheting, and Embroidery

Each article must have been made since the 2023 Fair by a Youth under the age of 18..... All articles must be clean and properly blocked. Each article will be judged by degree of difficulty of pattern.

Class

-Knitting.....	\$3.00	\$2.50	\$2.00
-Beginners (purl and/or knit)			
1. Head Band or Head Hugger			
2. Triangle Head Scarf or Neck Scarf			
3. Slippers			
4. Simple Shell			
5. Miscellaneous Articles			
-Intermediate (patterned article with special stitches)			
6. Mittens and Head Huggers			
7. Socks			
8. Basic Cardigan Sweater (with buttons)			
9. Miscellaneous Articles			
-Advanced (two or more colors of yarn used)			
10. Garment with design			
11. Miscellaneous Articles			

The Great Stoneboro Fair

- Crocheting \$3.00 \$2.50 \$2.00
- Beginners (single or double crochet)
 - 12. Scarf or Head Band
 - 13. Belt, Purse, or Hat
 - 14. Mittens or Slippers
 - 15. Miscellaneous
- Intermediate (half double crochet, treble crochet)
 - 16. Sweater, Vest, or Poncho
 - 17. Shawl or Scarf
 - 18. Accessories (Tie, Belt, Mittens, Purse, Hat)
 - 19. Miscellaneous
- Advanced (patterned stitches, i.e.: shell, cluster, popcorn, puff)
 - 20. Sweater, Vest, or Poncho
 - 21. Dress, Coat, Jacket, or Skirt
 - 22. Accessories (Hat, Gloves, Socks, Scarf)
 - 23. Miscellaneous Articles
- Embroidery \$3.00 \$2.50 \$2.00
 - 24. Dollies
 - 25. Pillow Cases
 - 26. Pictures
 - 27. Miscellaneous

SECTION 4 Art

1. All Youth between the age of 5 and 18 years may exhibit..
2. Entries must have been made by Exhibitor since the 2023 Fair.
3. Only original work will be accepted. No commercial kits will be allowed.
4. Paintings must be framed in wood or metal frames and be ready to hang.
5. Only one article in each division of a class will be accepted.

Class

- Painting..... \$3.50 \$2.50 \$1.50
- Crayon or Marker
 - 1. Age 5-8
 - 2. Age 9-12
 - 3. Age 13-18
- Oil/Acrylics
 - 7. Age 5-8
 - 8. Age 9-12
 - 9. Age 13-18
- Pen or Pencil
 - 10. Age 5-8
 - 11. Age 9-12
 - 12. Age 13-18
- Mixed Media
 - 4. Age 5-8
 - 5. Age 9-12
 - 6. Age 13-18
- Watercolor
 - 13. Age 5-8
 - 14. Age 9-12
 - 15. Age 13-18
- Pastel and/or Charcoal
 - 16. Age 5-8
 - 17. Age 9-12
 - 18. Age 13-18
- Textile Painting
 - 19. Age 5-8
 - 20. Age 9-12
 - 21. Age 13-18

SECTION 5
Photography

1. All Youth between the ages of 6 and 18 years of age may exhibit.
2. All exhibits **must be matted** with total dimensions not to exceed 12" x 14."
3. Photos must have been taken since the 2023 Fair by the Exhibitor, except photos taken during the 2023 Fair.
4. A maximum of 6 photographs per Exhibitor will be accepted.
5. See "Department 19, Section 2" for definitions of terms.

Class

-Black & White Ages 6-13	\$3.00	\$2.00	\$1.00
1. Landscape		7. Buildings	
2. Animals - Domestic & Wildlife		8. Portraiture	
4. Human Activity		9. Still Life	
5. Flowers			
-Color Ages 6-13	\$3.00	\$2.00	\$1.00
9. Landscape		19. Buildings	
12. Domestic Animals/Wildlife		20. Still Life	
14. Portraiture		21. Computer-enhanced	
15. Human Activity			
16. Flowers			
-Black and White Ages 14-18	\$3.00	\$2.00	\$1.00
32. Landscape		36. Flowers	
33. Animals - Domestic		38. Architecture	
34. Animals - Wildlife		39. Portraiture	
35. Human Activity		40. Still life	
-Color Ages 14-18	\$3.00	\$2.00	\$1.00
41. Landscape		48. Portraiture	
43. Domestic Animals		49. Human Activity	
44. Wildlife		50. Architecture	
45. Flowers		51. Still Life	
		52. Computer-enhanced	
-Sepia Ages 14-18	\$3.00	\$2.00	\$1.00
53. Landscape		60. Architecture	
55. Domestic Animals		61. Still Life	
56. Wildlife		62. Computer-enhanced	
57. Portraiture			
58. Human Activity			

The Great Stoneboro Fair

SECTION 6

Crafts

1. All Youth under 18 years of age may exhibit.
2. All exhibits must have been made by the Exhibitor. No commercial articles will be accepted.
3. Ceramic articles should have identification marks to indicate they are originals.
4. Only one (1) item in each class or sub-division will be accepted.

PREMIUMS\$3.00 \$2.00 \$1.00

Youth Crafts

1. Basketry
2. Bead Work
3. Ceramics
4. Button Art—must include a minimum of 10 buttons
5. Creative Holiday Articles
6. Creative or Traditional Dolls—must have extremities
7. Christmas Ornaments
8. Decorated Flip Flops
10. Handcrafted Greeting Cards (set of 3- different designs)
11. Scrapbook—single or double page
12. Model Cars
13. Model Trucks
14. Other Models
15. Birdhouse or Bird Feeder
16. Pot Holders—one pair
17. Sculpture
18. Wood Crafts
19. Wall Hanging
20. Metal Tooling
21. Shell, Nuts, or Cone Work
22. Lego Structure
23. K-Nex Structure
24. Any hand-crafted item depicting the theme “Down on the Farm”
25. Recycled
26. Crop Art



**Entry Day for Fine Arts and
Rabbits ONLY
will be Tuesday, August 27th
From 8 AM - 8 PM.**

DEPARTMENT 12

Grains & Seed Crops

SECTION 1

(Open Classes)

Class

-Corn (6 ears each)

- 1. Hybrid (White or Yellow Field).....\$4.00 \$3.00 \$2.00
- 2. Ornamental Large Indian
- 3. Ornamental Mini Indian
- 4. Ornamental Strawberry
- 5. Ornamental Pearl
- 6. Ornamental Rice
- 7. Ornamental Popcorn

-Corn (3 stalks)

- 8. Field-Pioneer - Book Family Seed Sales, sponsor, will donate 1 bag of seed corn to 1st place winner.
- 9. Silage— NK Seed - Lakeview Fertilizer, Inc., sponsor, will donate 1 bag of seed corn to 1st place winner.
- 10. Sunflowers (1 stalk)

SMALL GRAINS

Exhibits grown in 2023-2024

(1 Quart to be exhibited)

- Winter Barley\$4.00 \$3.00 \$2.00
 - 11. Pencco
 - 12. Pennrad
 - 13. Wyson
 - 14. Any Other
- Buckwheat
 - 15. Japanese or Silverhull
 - 16. Mancan
- Oats
 - 17. Hercules
 - 18. Larry
 - 19. Noble
 - 20. Oagle
 - 21. Pennlo
 - 22. Porter
 - 23. Pennuda
 - 24. Any Other
 - 25. Rye
- Wheat and Other Grains
 - 26. Fillmore
 - 27. Hart
 - 28. Scotty
 - 32. Corn, Shelled
 - 33. Speltz
 - 34. Alfalfa - Seed 1 Qt.....\$2.00 \$1.50 \$1.00
 - 35. Red Clover - Seed
 - 36. Soy Beans - Seed
 - 37. Sunflower
 - 38. Timothy
 - 39. Any Other
 - 40. Popcorn, Shelled
 - 41. Hops
 - 29. Titan
 - 30. Tyler
 - 31. Any Other

**SECTION 2
HAY**

Long Hay only (an exhibit shall consist of a bale section approximately 8" thick, or an equivalent amount of cut from hay in the mow).

PREMIUMS Classes 1-12 \$12 \$9 \$6 \$4 \$2
FIELD CURED OR PARTIAL FIELD CURE PLUS MOW
FINISHED
(NO HEAT)

Class

1. **Alfalfa.** Alfalfa with not over 10 percent of grasses. First cutting.
2. **Alfalfa.** Alfalfa with not over 10 percent of grasses. Later cutting.
3. **Alfalfa grass mixed.** A mixture of alfalfa and grasses with over 10 percent but not over 50 percent of grasses. First cutting.
4. **Alfalfa grass mixed.** A mixture of alfalfa and grasses with over 10 percent but not over 50 percent of grasses. Later cutting.
5. **Clover.** Clover with not over 20 percent of timothy or other grasses.
6. **Clover-grass mixed.** A mixture of clover and grass with over 20 percent but less than 50 percent of grasses.
7. **Grass.** Mixtures of timothy and/or other grasses and containing not more than 10 percent legumes. First cutting.
8. **Grass.** Mixtures of timothy and/or other grasses and containing not more than 10 percent legumes. Later cutting.
9. **Mixed - More than 50 percent of legumes.** Any mixture not classified in the previous classes but which contains 50 percent or more singly or in combination of alfalfa, trefoil, clover, and grasses.
10. **Mixed - More than 50 percent of grasses.** Any mixture not classified in the previous classes but which contains 50 percent or more singly or in combination of alfalfa, trefoil, clover, and grasses.

PARTIALLY FIELD-CURED PLUS HAY PRESERVATIVE

11. **Alfalfa.** Alfalfa with not over 10 percent of grasses. First cutting.
12. **Alfalfa.** Alfalfa with not over 10 percent of grasses. Later cuttings.
13. **Grand Champion.** All classes competing - BANNER
14. **Reserve Grand Champion - BANNER**

SECTION 3
SILAGE

Silage-crop must be named. Exhibits shall consist of 10 pounds of silage. Large-size plastic bags are excellent containers for transporting or showing samples as are wide-mouth plastic or glass jars.

PREMIUMS.....\$3.00 \$2.00 \$1.00

Class

1. Perennial crops-direct cut, with or without preservative
2. Perennial crops-wilted or low moisture, with or without preservatives
3. Annuals other than corn-direct cut, with or without preservatives
4. Annuals other than corn, wilted or low moisture, with or without preservatives
5. Corn Silage



Pure Perfection.

DEPARTMENT 13 VEGETABLES

**ALL Exhibitors MUST provide their OWN PLATES
for Exhibition in EACH category.**

RULES AND REGULATIONS GOVERNING VEGETABLES

1. In selecting vegetables for exhibition, choose such specimens that would bring the highest market price. Do not select the largest; select medium size specimens. If at all possible, do not mix varieties.
2. The following factors are generally used by an expert vegetable judge:
 - a. Trueness to variety type. If at all possible, pick the specimens from one variety.
 - b. Uniformity in size, shape and color.
 - c. Be sure to pick out the perfect specimen, then select the other as similar to it as possible. Never mix specimens of different maturity.
 - d. Protect from dirt, disease, infection, and mechanical damage. Select specimens that are perfect and show no blemishes of any kind.
 - e. Condition and maturity. Be sure that exhibits are of high quality.
 - f. Potatoes should not be washed. Remove soil using a soft cloth or brush.
 - g. Tomatoes should have stems removed. Carrots, beets, etc. should have tops (leaves) removed leaving about two inches of stems.

PREMIUMS.....\$4.00 \$3.00 \$1.00

-BEANS - Dry Shelled (1 pt.)

1. Edible soybeans
2. Horticultural
3. Kidney
4. Marrowfat
5. Pea or Navy
6. Lima
- BEANS - Green Shelled (1 pt.)
7. Edible soybeans
8. Horticultural
9. Large seeded limas
10. Small seeded limas
- BEANS - Horticultural (1 pt. pods)
11. Bush types
12. Pole types
- BEANS - Lima - (15) Pods
13. Large seeded
14. Pole Limas
15. Small seeded
- BEANS - Snap, bush type

-BEANS - Snap, bush type (1 pt.)

16. Flat green pods
17. Flat yellow pods
18. Round green pods
19. Round yellow pods
- BEANS - Snap. pole types
20. Flat green pods
21. Round green pods
22. Round yellow pods
23. Flat yellow pods
- BEETS - 5 specimens, topped
24. Globe shaped
25. Half long
26. Long Lutz type
27. Mangels
28. Broccoli - 1 large head
29. Brussell Sprouts (1 pt.)
- CABBAGE - 1 head
30. Chinese type
31. Early pointed
33. Domestic round
34. Flat types
35. Red types

The Great Stoneboro Fair

- 36. Savory types
- CARROTS - 5 roots, topped
- 37. Half long (pointed)
- 38. Half long (stump rooted)
- 39. Long
- CAULIFLOWER - head
- 40. Purple types
- 41. White types
- CELERY- plant in soil
- 42. Green types
- 43. Yellow types
- CORN (sweet)
- 5 ears, husks on
- 44. White hybrids
- 45. Yellow hybrids
- 46. Other types
- CUCUMBERS - 5 specimens
- 47. Pickling (under 3") (1 pt.) on paper plate
- 48. Pickles (3" to 5")
- 49. Slicing (over 5")
- 50. Eggplant - 1 specimen
- ENDIVE -1 plant in soil
- 51. Broad leaved
- 52. Green curled
- 53. Garlic - 5 bulbs
- 54. Horse-Radish - 3 roots (1" minimum diameter)
- 55. Kale - 1 plant in soil
- 56. Kohlrabi - 1 specimen
- 57. Leek - 5 stalks
- MUSKMELONS - one specimen
- 61. Large types (6" or more)
- 62. Small types
- 63. Okra - 5 specimens
- ONIONS - (bulbs)
- 5 specimens mature for storage
- 64. Bottle
- 65. Red flat
- 66. Red globe
- 67. Sweet Spanish type
- 68. White flat
- 69. White globe
- 70. Yellow flat
- 71. Yellow globe
- ONIONS - (bulbing)
- 4 specimens
- 72. Green bunching
- ONIONS - (set)
- 1 pt. mature for storage
- 73. Multiplier
- 74. Red
- 75. White
- 76. Yellow sets
- PARSLEY - 2 bunches in water
- 77. Curled type
- 78. Plain type
- PARSNIPS - (root)
- 5 roots with tops
- 79. Hamburg or Turnip, rooted
- 80. Parsnips - 5 specimens tops off
- PEAS - 1 pt.
- 81. Green shelled
- 82. Pods
- PEPPERS - (hot) 5 specimens
- 83. Long type
- 84. Round type
- 85. Small type
- 95. Jalapeno
- PEPPERS - (pimento)
- 5 specimens
- 86. Green
- 87. Red
- PEPPERS (sweet-bell or bull-nose shape) 5 specimens
- 88. Green
- 89. Red
- 90. Yellow
- PEPPERS (sweet long thin fleshed) 5 specimens
- 91. Green
- 92. Red
- 93. Yellow
- POTATOES - 5 tubers
- 94. Chieftain
- 98. Norland
- 99. Irish Cobblers
- 100. Katahdin
- 101. Kennebec
- 102. Russets-rural
- 104. Steuben
- 105. Superior
- 106. Pontiac
- 107. Other
- 108. Potatoes - Sweet 5 specimens
- PUMPKINS - 1 specimen
- 109. Connecticut Field
- 110. Small Sugar, Pie
- 111. Winter Neck
- 112. Largest Pumpkin - weight to be on tag and attached to specimen

The Great Stoneboro Fair

- RADISHES (summer)
 - 5 specimens
 - 113. Small round
 - 114. White icicle
- RADISHES (winter)
 - 5 specimens
 - 115. Black
 - 116. White
- RHUBARB
 - 117. Any variety-three stalks tied together
- RUTABAGAS
 - 118. Any variety - 3 specimens topped
- SQUASH (Summer types)
 - 1 specimen
 - 119. Bush scallop - Patty Pan
 - 120. Cocozelle
 - 121. Crookneck
 - 122. Straightneck
 - 123. Zucchini
- SQUASH (Winter types)
 - large - 1 specimen
 - 124. Acorn or Table Queen
 - 125. Delicious or Boston Marrow
 - 126. Golden Nugget
 - 127. Hubbard
 - 128. Mammoth-Sweet types
 - 129. Largest single squash specify weight on entry blank.
 - 130. Buttercup
 - 131. Butternut
- SWISS CHARD
 - 132. Any variety - 1 stalk in soil
- TOMATOES (large fruited)
 - 5 specimens
 - 133. Italian
 - 134. Green
 - 135. Pink
 - 136. Red
 - 137. Yellow
- TOMATOES (small fruited)
 - 138. Cherry - 10 specimens or 5 clusters
 - 139. Pear shaped - 10 specimens
 - 140. Plum shaped - 10 specimens
 - 141. Husk or Ground Cherry - 1 quart
- TURNIPS - 3 specimens
 - 142. Any variety (topped)
 - 143. Spaghetti Squash
- WATERMELONS - 1 specimen
 - 144. Largest single watermelon
 - 145. Midget types
 - 146. Oblong in shape
 - 147. Round or oval
 - 148. Honey Dew
- GOURDS
 - 149. Mixed - 5 specimens
 - 150. One variety - 5 specimens
 - 151. Collection - 6 or more kinds attractively displayed Unlimited number of specimens
 - 152. Herbs - Collection - 6 or more attractively displayed. Unlimited number of specimens
 - 153. Vegetable Freaks
 - 154. Home Garden - Display 10 or more vegetables, not fewer than 3 specimens of each
 - 155. Fresh Dill
 - 156. Spaghetti Squash

DEPARTMENT 14

Fruits-Nuts

ALL Exhibitors MUST provide their OWN PLATES for exhibition in EACH category.

Refer to General rules

FRUITS

1. In selecting apples for exhibition, choose specimens of medium size. Have five specimens as nearly alike as possible in plated displays.
2. The following score is to be used as a basis for the judging of all plate exhibits: TOTAL POINTS — 100

Exterior Quality Condition	12 points
Size (Total weight)	16 points
Uniformity of Color	12 points
Shell Texture	12 points
Interior Quality	36 points
Uniformity of Shape	12 points

3. Each Exhibitor must designate the particular premium for which he/she is competing in special classes, and see that the packages are properly tagged. Single specimens may not be considered or shown in variety classes.
4. Premiums will be awarded only when the exhibit complies with the standard, is meritorious, and is properly named.

SECTION 1

APPLES

Part 1 - COMMERCIAL VARIETIES

The following shall be classified and judged as such:

PREMIUMS Plate of 5 \$4.00 \$3.00 \$2.00

Class

- | | |
|-----------------------|---|
| 1. Cortland | 8. Jonathan |
| 2. Delicious | 9. Lodi |
| 3. Double Red Rome | 10. McIntosh |
| 4. Double Red Stayman | 11. Rambo - Summer |
| 5. Double Red York | 12. Starking or Double Red
Delicious |
| 6. Golden Delicious | 13. Stayman |
| 7. Grimes Golden | 14. Yellow Transparent |

ENTRIES CLOSE

WEDNESDAY, AUGUST 7, 2024
SPACE IS LIMITED, SO ENTER EARLY!

The Great Stoneboro Fair

SECTION 2 - OTHER VARIETIES

The following shall be classified and judged as such:

PREMIUMS Plate of 5	\$4.00	\$3.00	\$2.00
Class			
1. Baldwin		10. Rambo-Winter	
2. Fallowwater or Pound		11. Rhode Island	
3. Gano		Greening	
4. Maiden Blush		12. Smoked House	
5. Northern Spy		13. Stark	
6. Northwestern Greening		14. Wagner	
7. Old Fashioned Winesap		15. Williams Early Bird	
8. Opalescent		16. Winter Banana	
9. Paradise		17. Wolf River	
18. Snow			
19. Bushel Basket - any variety	\$6.00	\$5.00	\$4.00

SECTION 3 - PEACHES

PREMIUMS Plate of 5	\$4.00	\$3.00	\$2.00
Class			
1. Belle of Georgia		5. J.H. Hale	
2. Elberta		6. Red Haven	
3. Golden Jubilee		7. Rare Ripe	
4. Hale Haven		8. Any other variety	

SECTION 4 - PEARS

Single Plates, 5 of any below named variety	\$4.00	\$3.00	\$2.00
Class			
1. Bartlett		5. Kiefer	
2. Duchess		6. Laconte	
3. Gorham		7. Seckel	
4. Bosc		8. Sheldon	
9. Display of 5 each of 5 varieties	\$6.00	\$5.00	\$3.00
correctly named			
10. Standard Box			

SECTION 5 - PLUMS

Single Plates, 5 of any below named varieties.....	\$3.00	\$2.00	\$1.00
Class			
1. Abundance		7. German Prune	
2. Albion		8. Italian Prune	
3. Blue Damson		9. Red Egg	
4. Blue Gage		10. Shiro	
5. Burbank		11. Stanley Prune	
6. Elephant Heart		12. Yellow Egg	
13. Display of 5 each of 5 varieties	\$5.00	\$4.00	\$3.00

The Great Stoneboro Fair

SECTION 6 - QUINCES

-5 of any named variety	\$3.00	\$2.50	\$2.00
Class			
1. Apple		3. Flowering	
2. Champion		4. Orange	

SECTION 7- BERRIES

1 Pt.

-Single plate	\$3.00	\$2.00	\$1.50
1. Blackberries		5. Currants	
2. Blueberries		6. Gooseberries	
3. Red Raspberries		7. Strawberries	
4. Elderberries		8. Black Raspberries	
10. Display of 5 or more varieties	\$5.00	\$4.00	\$3.00

SECTION 8 - WILD BERRIES

-Single plate	\$2.00	\$1.50	\$1.00
Class			
1. Barberry		5. Partridge	
2. Bittersweet		6. Poke	
3. Black Haws		7. Gray Stem Dogwood	
4. Dog Wood			
8. Display of 5 or more varieties	\$3.00	\$2.00	\$1.50

SECTION 9 - GRAPES

Plate - 3 bunches, any below named varieties			
.....	\$4.00	\$3.00	\$2.00
Class			
1. Concord	3. Fredonia	5. Niagara	7. White
2. Delaware	4. Moore Early	6. Ontario	8. Any Other
9. Fancy basket assorted native grapes	\$6.00	\$4.00	\$2.00

SECTION 10 - FRESH NUTS

All nuts must have been grown in a community surrounding the Fair within the past year. Ten specimens of each variety are to be entered.

PREMIUMS	\$4.00	\$3.00	\$2.00
Class			
1. American Black Walnuts		4. Nuts Hickories Shell/Shag Bark	
2. Butternuts, any variety		5. Assorted groups of any 5	
3. Nuts-Native American or Chinese Chestnuts		6. Other	

SECTION 11 - DRIED NUTS

PREMIUMS	\$4.00	\$3.00	\$2.00
Class			
1. American Black Walnuts		4. Nuts-Hickories Shell/Shag Bark	
2. Butternuts, any variety		5. Assorted groups of any 5	
3. Nuts Native American or Chinese Chestnuts		6. Other	

THANK YOU!

Mercer County State Bank

Auction Winner of the 2023 Great Stoneboro Fair

Angel Food Cake Contest

Baked by Elizabeth Shearer



*Your Support of the 2023 Baked Goods' Auction
was greatly appreciated.*

**Join Us This Year at 6:00 PM, Thursday, August 29th,
for the 2024 Baked Goods Auction in the Ibbs Building**

DEPARTMENT 15 - FOODS HOME AND DAIRY PRODUCTS

ALL Exhibitors MUST provide their OWN PLATES for exhibition in EACH category.

All baked goods will be auctioned at 6:00 PM on Thursday, August 29th, 2024 in the Ibbs Building. If you do not wish to have your entry sold, please indicate that when entering. All products must have been made by the Exhibitor. Premiums will not be paid for commercial products.

Baked items must be on a paper/plastic plate and in a clear plastic bag.

No baked goods will be accepted which require refrigeration.

No Exhibitor may enter more than one article in each subdivision of a class.

Youth under 19 may enter in Department 11.

SECTION 1 - BAKED PRODUCTS

Baked products will be judged on flavor, lightness, general appearance, and crumb. Pies are to be judged on texture of crust and flavor and consistency of filling.

**PLEASE SEE DEPARTMENT 22:
APPLE PIE CONTEST, CHOCOLATE CAKE CONTEST,
PA PREFERRED JUNIOR BAKING CONTEST,
ANGEL FOOD CAKE CONTEST**

PREMIUMS\$5.00 \$4.00 \$3.00 \$2.00

Class

-Quick Breads

1. Baking Powder Biscuits - ½ dozen
2. Corn Bread, 4 pieces approximately 2½" x 3"
3. Muffins- ½ dozen
4. Nut Bread or other Fruit Bread
5. Vegetable Quick Bread

-Yeast Breads - to consist of one rectangular ½ loaf, approximately 4"x4"x5", wrapped in plastic. No fork pricks.

6. White Bread
7. Gluten Free Bread
8. Whole Wheat Bread
9. Artisan Bread (any shape)

-Rolls - to consist of six rolls of uniform shape and size wrapped in a plastic bag.

10. Cinnamon Rolls
11. Doughnuts
12. White Rolls
13. Whole Wheat Rolls

-Butter Cakes, Iced

14. Chocolate
15. Spice
16. White
17. Yellow
18. Gluten Free Cake
19. Cupcakes, 4, White or Chocolate

-Egg Cakes, Not Iced

20. Chiffon
21. Sponge

The Great Stoneboro Fair

- Decorated Cakes - judged on decoration only-Real or Styrofoam Form
 - 22. Floral
 - 23. Novelty
- Pies
 - 26. One Crust Pie, Any Kind except cream-filled or custard
 - 28. Two Crust Pie, Any Kind
- Candy - ½ pound to be shown\$5.00 \$4.00 \$3.00 \$2.00
 - 29. Chocolate Covered
 - 30. Chocolate Fudge
 - 31. Divinity Fudge
 - 32. Fondant
 - 33. Light Fudge
 - 34. Sea Foam
 - 35. Other
- Cookies - one-half dozen on a paper/plastic plate
- PREMIUMS\$5.00 \$4.00 \$3.00 \$2.00
 - 36. Bar Cookies
- Drop Cookies-
 - 37. Chocolate (includes chips)
 - 38. Iced
 - 39. Un-iced
 - 40. Pressed Cookies
 - 41. Rolled Cookies
 - 42. Filled Cookies
 - 43. Sliced or Ice Box Cookies

SECTION 2 CANNED OR DRIED PRODUCTS

1. Canned foods will be judged on quality, general appearance, and container.
2. Use standard Mason-type, clear, clean quart/pint glass jars for preserving and exhibiting fruits, vegetables, and meats.
3. Use two-piece self-sealing lids only (flat discs and metal screw bands) for sealing all jars of food. **NO DECORATIVE DOILIES.**
4. Metal screw bands may be removed or allowed to remain at the Exhibitor's preference. Metal screw bands will be removed for judging.
5. All food not in standard jars or sealed with self-sealing lids will be disqualified by the Judge.
6. All entries must have been made since the last Fair by the person whose name appears as the Exhibitor.
7. The Judges are **NOT** permitted to open and sample canned goods.
8. No Exhibitor may enter more than one article in each subdivision of each class.

Class

- Canned Fruits, 1 quart or pint jar\$1.75 \$1.50 \$1.25 \$1.00
 - 1. Apples
 - 2. Applesauce
 - 3. Blackberries
 - 4. Blueberries or Huckleberries
 - 5. Cherries, Dark, with pits
 - 6. Cherries, Red, sour pitted
 - 7. Cherries, White, with pits
 - 8. Elderberries
 - 9. Peaches
 - 10. Pears
 - 11. Raspberries, Black
 - 12. Raspberries, Red
 - 13. Rhubarb
 - 14. Other
- 15. Best Display of Canned Fruits, 3 jars ...\$4.00 \$3.00 \$2.00 \$1.00

The Great Stoneboro Fair

-Canned Vegetables - one-quart jar, except corn or peas which may consist of a one-pint jar

- | | |
|---|--------------------|
| 16. Asparagus | 24. Peas |
| 17. Beans, Green | 25. Pumpkin |
| 18. Beans, Lima | 26. Sauerkraut |
| 19. Beans, Yellow | 27. Spinach |
| 20. Beets | 28. Succotash |
| 21. Carrots | 29. Swiss Chard |
| 22. Corn | 30. Tomatoes |
| 23. Mixed Vegetables | 31. Vegetable Soup |
| 24. Peas | 32. Other |
| 33. Best Display of Canned Vegetables, 3 jars | |

..... \$4.00 \$3.00 \$2.00 \$1.00

-Canned Meat - 1 quart \$1.75 \$1.50 \$1.25 \$1.00

- | | |
|-------------|-----------|
| 34. Beef | 36. Pork |
| 35. Venison | 37. Other |

-Pickles and Relishes - One pint or one quart to be judged on size, uniformity, clarity, color, and arrangement \$1.75 \$1.50 \$1.25 \$1.00

- | | | |
|-----------------|----------------------|-------------|
| 42. Beans | -Cucumber | |
| 43. Beets | 46. Bread and Butter | 49. Mustard |
| 44. Cauliflower | 47. Dill | 50. Sour |
| 45. Chow Chow | 48. Mixed | 51. Sweet |
| | | 52. Other |

-Peppers

- | | | |
|----------------|------------------|---------------------|
| 54. Hot | -Relishes | -Sauces |
| 55. Sweet | 57. Corn | 62. Catsup |
| 56. Piccalilli | 58. Pepper | 63. Chili Sauce |
| | 59. Green Tomato | 64. Spaghetti Sauce |
| | 60. Zucchini | 65. Salsa |
| | 61. Other | 66. Miscellaneous |

-Spiced Fruit - one quart or pint jar \$1.75 \$1.50 \$1.25 \$1.00

67. Any Spiced Fruit

-Dried Fruits and Vegetables - one quart or pint jar, to be judged on quality and general appearance \$1.75 \$1.50 \$1.25 \$1.00

68. Any Dried Fruits and Vegetables or Herbs

-Juices - one quart jar, to be judged on flavor, color, and clarity

..... \$1.75 \$1.50 \$1.25 \$1.00

- | | |
|-------------------|------------|
| 69. Apples | 72. Tomato |
| 70. Grapes | 73. Other |
| 71. Vinegar-Cider | |

The Great Stoneboro Fair

SECTION 3

BUTTERS, JAMS, JELLIES, MARMALADES, AND PRESERVES

Each entry must be in one ½ pint jelly glass with removable lid - NO paraffin. Entries will be judged on appearance, consistency, and neatness of package. Each entry must have been prepared by the Exhibitor within the year.

Class

-Butters	\$2.00	\$1.75	\$1.50	\$1.00
1. Apple				
2. Grape				
3. Peach				
4. Pear				
5. Plum				
6. Tomato				
7. Orange				
8. Apricot				
9. Quince				
10. Any Other				
-Jams	\$2.00	\$1.75	\$1.50	\$1.00
11. Blackberry				
12. Cherry				
13. Currant				
14. Elderberry				
15. Peach				
16. Plum				
17. Raspberry, black				
18. Raspberry, red				
19. Rhubarb				
20. Strawberry				
21. Any Other				
-Jellies	\$2.00	\$1.75	\$1.50	\$1.00
22. Apple				
23. Blackberry				
24. Cherry				
25. Crabapple				
26. Currant				
27. Elderberry				
28. Gooseberry				
29. Grape				
30. Huckleberry				
31. Peach				
32. Plum				
33. Quince				
34. Raspberry, black				
35. Raspberry, red				
36. Any Other				
37. Display of Jelly - three varieties	\$4.00	\$3.00	\$2.00	\$1.00
-Marmalades	\$2.00	\$1.75	\$1.50	\$1.00
38. Apricot				
39. Grape				
40. Grapefruit				
41. Orange				
42. Peach				
43. Pear				
44. Pineapple				
45. Plum				
46. Tomato, yellow				
47. Any Other				
-Preserves and Conserves	\$2.00	\$1.75	\$1.50	\$1.00
48. Apricot				
49. Blueberry				
50. Cherry				
51. Peach				
52. Pear				
53. Pineapple				
54. Plum				
55. Quince				
56. Strawberry				
57. Tomato				
58. Any Other				

DEPARTMENT 17 FLORAL EXHIBITS

Refer to General Rules.

FLORAL EXHIBITS

Rules and Regulations governing entering, placing, and removing of plants and flowers determined by each Fair:

1. The use or displaying of **artificial** flowers is prohibited, and no premiums will be paid.
2. Plants positively will not be accepted for exhibition unless they have been growing in containers used for show for at least four months.
3. The Management will not undertake to return exhibits or be responsible for the return of exhibits. Baskets or containers must be supplied by the Exhibitor and will be given every possible care, but the Management assumes no responsibility for their safety.
4. Flowers and plants entered for competition must be more than ordinary standard and quality to be entitled to an award.
5. All entries must be grown by the Exhibitor except in arrangement classes.
6. The Judge may recommend a special award for any meritorious exhibit not provided for in the schedule.
7. No entry can be removed until Monday evening at 8:00 PM. This class includes all plants that would qualify as house plants. Only one species per pot is permitted except in collections. Pots are not to exceed 10" in width, and plants must be growing in said container four months prior to the Fair.

SECTION 1 FLOWERING PLANTS

PREMIUMS\$3.00 \$2.50 \$2.00

Class

-African Violets - any color

1. Single
2. Double
3. Episcia

-Wax Begonias, fibrous, rooted, in bloom

3. Single, any color
4. Double, any color

-Begonia, tuberous, rooted, in bloom

5. Single or Semi-Double, any color
6. Double, any color
7. Geranium, any color
8. Gloxinia

-Hanging Baskets

9. Begonias
10. Impatiens
11. Any other similar flowering plant not listed above

The Great Stoneboro Fair

SECTION 2 FOLIAGE PLANTS

Only one species per pot is permitted. Pots are not to exceed 10" in width.

PREMIUMS \$3.00 \$2.50 \$2.00

Class

-Begonias, foliage type with or without flowers

1. Large leaf, any variety
2. Small leaf, any variety

-Cacti

3. One pot
4. Cactus Garden

-Coleus

5. Common Coleus
6. Fringed Type Coleus
7. Largest potted, any variety
8. Coleus, any leaf color

-Miscellaneous Plants

9. Ferns, any variety
10. Geranium, any variety
12. Potted Ivy, any variety
13. Dish garden or foliage plants - three or more specimens
14. Succulents
15. Philodendron
16. Croton
17. Palm, any variety
18. Oxalis — Shamrock
19. Rubber Plant
20. Most Unusual Plant
21. Any other similar foliage plant not listed above

SECTION 3 SPECIMEN FLOWERS - ANNUALS

1. Exhibits in this division must be cut flowers grown by the Exhibitor and must conform to the number of blooms, spikes, or stems as specified in each class.
2. The uniformity of height, color, or size is an important factor in evaluating entries.
3. Flowers in each entry must be of one color and variety unless otherwise stated.

PREMIUMS \$3.00 \$2.50 \$2.00

Class

1. Ageratum, five stems
2. Aster, five blooms
3. Bells of Ireland, five stems
4. Calendula, five blooms
5. Crested Celosia, one stem
6. Astilbe, five stems
7. Cleoma (Spider Flower)
5 stems
8. Cosmos, five blooms

The Great Stoneboro Fair

-Dahlias

- | | |
|----------------------|----------------------------|
| 9. Cactus, 2 blooms | 10. Decorative, 3 blooms |
| 11. Pompom, 3 blooms | 12. Dinner Plates, 1 bloom |

-Gladiolus, 1 spike

- | | |
|---------------------|---------------------|
| 13. Large Flowering | 14. Small Flowering |
|---------------------|---------------------|

-Marigolds, 5 blooms

- | | |
|--|---|
| 15. African, lemon colored
(lg. type) | 16. African, orange (lg. type) |
| 17. French, single (Am. type) | 18. French, double (sm. type
yellow) |
| 19. French, double (sm. type
orange) | 20. French double (sm. type
bicolor) |

-Nasturtiums, 5 Blooms

- | | |
|------------------------------|------------------------------|
| 21. Single | 22. Double |
| 23. Pansy, 5 blooms | |
| 24. Single Petunia, 5 blooms | 25. Double Petunia, 5 blooms |

26. Rudbeckia (Gloriosa
Daisy) 5 blooms

27. Salvia, any color

29. Scabiosa, 5 blooms

31. Strawflowers, 5 blooms

30. Snapdragons, 5 spikes

32. Sweet Peas, 5 stems
mixed

-Zinnias, mixed colors

33. Giant, 3 blooms

35. Pompom, 6 blooms

37. Bachelor Buttons,
5 blooms

34. Cactus, 3 blooms

36. Novelty, 6 blooms

38. Other annuals, 5 blooms

39. Gerbera Daisy, 5 blooms

SECTION 4

SPECIMEN FLOWERS - PERENNIALS

1. Exhibits in this division must be cut flowers grown by the Exhibitor and must conform to the number of blooms, spikes, and stems specified in each class.
2. The uniformity of height, color, or size is an important factor in evaluating entries.
3. Flowers in each entry must be of one color and variety unless otherwise stated.

PREMIUMS

\$3.00 \$2.50 \$2.00

Class

-Chrysanthemums, 5 stems

- | | |
|----------------------------|--|
| 1. Single or Daisy type | 5. Delphinium, one spike |
| 2. Spider or Japanese type | 6. Dianthus (Hardy Pinks), five blooms |
| 3. Cushion type | 7. Lillies, one stalk |

-Roses

-Hybrid, 1 flower

- | | | |
|-----------------------|------------------------|-------------------------|
| 8. Bicolor | 9. Orange | 10. Pink |
| 11. Red | 12. White | 13. Yellow |
| 14. Lavender | 15. Floribunda, 1 stem | 16. Grandiflora, 1 stem |
| 17. Miniature, 1 stem | 18. Other Perennials | |

The Great Stoneboro Fair

**SECTION 5
ARTISTIC ARRANGEMENTS**

1. Maximum care will be taken of the containers and accessories until they can be reclaimed by Exhibitors, but the Fair cannot be held responsible for any damage or loss.
2. **The use of artificial flowers is prohibited.**

PREMIUMS\$5.00 \$4.00 \$3.00
Class

1. Arrangement of wild flowers. Plants forbidden by conservation rules cannot be used.
2. Arrangement using dried materials
3. Arrangement in a tea pot or other piece of china
4. Arrangement using one type of flower
5. Arrangement depicting a holiday or special occasion
6. All white arrangement
7. Depicting a department of the Fair, must contain flowers
8. Fairy Gardens

**SECTION 6
SPECIAL CATEGORY**

"Dragons, Fairies, and Wizards"

Theme for 2024\$6.00 \$5.00 \$4.00

**C. Sullivan Electric
Stoneboro Pa.**



- Residential
- Commercial
- Industrial

**Phone 724-376-8871
Cell 724-967-2477**

DEPARTMENT 18 - Needlecraft

Refer to General Rules.

1. No article can compete in more than one category.
2. All clothing must be laundered and pressed.
3. Each exhibit will be judged on workmanship, worth of article, and appropriateness of material and design.
4. All articles must have been completed by the Exhibitor since the close of the 2023 Fair.
5. Youth may enter in Department 11, according to guidelines provided in each section of Department 11.

SECTION 1 Clothing

Class

-Aprons	PREMIUMS	\$3.00	\$2.00	\$1.50
1. Child's or Adult's apron				
-Children's Garments		\$4.00	\$3.00	\$2.00
2. Boy's suit (pants and shirt 1 to 12 years)				
3. Girl's suit (1 to 12 years)				
-Dress				
4. Infant's				
5. Girl's (1 to 12 years)				
-Slacks				
6. Boy's (1 to 12 years)				
7. Girl's (1 to 12 years)				
8. Shirt/Blouse				
9. Skirt (1 to 12 years)				
10. Coat				
11. Halloween Costume				
-Dress		\$4.00	\$3.00	\$2.00
13. Sleeveless Dress or Jumper				
14. Street-Length Dress with sleeves (1 or 2 piece)				
15. Formal dress, floor or street length				
16. Hats		\$4.00	\$3.00	\$2.00
-Jackets, any fabric		\$7.00	\$5.00	\$3.00
17. Man's				
18. Woman's				
-Skirt, Blouses		\$4.00	\$3.00	\$2.00
21. Blouse with sleeves				
22. Blouse, sleeveless				
23. Cotton or Blend skirt				
24. Wool or wool Blend skirt				
-Slacks, any fabric		\$4.00	\$3.00	\$2.00
26. Woman's slacks				
28. Shorts				
-Suits		\$7.00	\$5.00	\$3.00
31. Woman's or Man's				

The Great Stoneboro Fair

-Vest	\$4.00	\$3.00	\$2.00
33. Any Fabric			
-Mending or repairing - single entry	\$4.00	\$3.00	\$2.00
34. Hand mending			
35. Machine mending			
36. Renovated or Remodeled clothing			
37. Decorated clothing			
38. Necktie			

SECTION 2 Needlework

Class			
-Holiday Decorations	\$4.00	\$3.00	\$2.00
1. Christmas			
2. Easter			
3. Other			
4. Centerpieces (under 12").....			
	\$4.00	\$3.00	\$2.00
5. Centerpieces (over 12")			
-Cushions	\$4.00	\$3.00	\$2.00
22. Embroidered			
23. Outline			
27. Counted Cross Stitch			
28. Crocheted			
29. Quilted			
30. Latch Hook			
31. Needlepoint			
32. Novelty			
33. Patchwork			
34. Other			
-Miscellaneous	\$4.00	\$3.00	\$2.00
-Toys			
35. Doll			
36. Stuffed Animal			
37. Other			
-Purses			
38. Knitted			
39. Crocheted			
40. Cloth			
41. Other			
-Potholders (2 each)			
42. Cloth			
43. Crocheted			
44. Knitted			
45. Woven			
-Useful articles			
46. Kitchen			
47. Bathroom			
48. Other			
-Sweat shirts			
49. Counted Cross Stitch			
50. Decorated			
52. Doll clothes			
53. Album covers			
54. Placemats (4)			
55. Tote or other handmade useful article			
-Pictures - over 4"	\$4.00	\$3.00	\$2.00
56. Crewel work			
57. Crocheted			
58. Needlepoint			
59. Cross Stitch			
62. Miniature picture (under 4")			
	\$3.00	\$2.00	\$1.50
-Wall hangings (over 15")	\$4.00	\$3.00	\$2.00
64. Embroidery			
65. Needlepoint			
66. Quilted			
67. Other			

The Great Stoneboro Fair

-Wall hangings (under 15")	\$4.00	\$3.00	\$2.00
68. Machine Quilted			71. Hand Quilted
69. Embroidery			72. Other
70. Needlepoint			
-Pillow Cases	\$4.00	\$3.00	\$2.00
73. Crocheted edge			
-Embroidered			
74. Applique		77. Cut Work	
75. Crewel work		78. Outline	
76. Cross Stitch		79. Painted	
-Dresser Scarves & Table Runners	\$4.00	\$3.00	\$2.00
80. Crocheted edge			
-Embroidered			
81. Counted Cross Stitch			
82. Outline			
83. Other			
-Tablecloths	\$5.00	\$4.00	\$3.00
84. Crocheted edge			
-Embroidered			
85. Applique		89. Outline	
87. Cross Stitch		90. Other	
91. Towels - decorated	\$3.00	\$2.00	\$1.50

SECTION 3

Knitted and Crocheted Wearing Apparel

Class

-Baby Bunting	\$3.00	\$2.00	\$1.50
1. Crocheted		2. Hand knit	3. Machine knit
-Booties, Cap & Sweater	\$3.00		\$2.00 \$1.50
4. Crocheted		5. Hand knit	6. Machine knit
-Caps, Hats	\$2.00	\$1.50	\$1.00
7. Crocheted		8. Hand knit	9. Machine knit
-Coat	\$3.00	\$2.50	\$2.00
10. Crocheted		11. Hand knit	12. Machine knit
-Dress	\$3.00	\$2.50	\$2.00
13. Crocheted		14. Hand knit	15. Machine knit
-Mittens or Gloves	\$3.00		\$2.00 \$1.50
-Adults		-Child's	
16. Crocheted		19. Crocheted	
17. Hand knitted		20. Hand knitted	
18. Machine knitted		21. Machine knitted	
-Socks, Slippers, Booties			
-Adult's		-Child's	
22. Crocheted		25. Crocheted	
23. Hand knitted		26. Hand knitted	
24. Machine knitted		27. Machine knitted	
-Sweater - cardigan			
-Child's		-Woman's	
28. Crocheted		31. Crocheted	
29. Hand knitted		32. Hand knitted	
30. Machine knitted		33. Machine knitted	

The Great Stoneboro Fair

-Man's			
34. Crocheted			
35. Hand knitted			
36. Machine knitted			
-Sweater - sleeveless pullover	\$3.00	\$2.50	\$1.50
-Child's			
37. Crocheted			
38. Hand knitted			
39. Machine knitted			
-Man's			
43. Crocheted			
44. Hand knitted			
-Sweater - pullover with sleeves	\$3.00	\$2.50	\$1.50
-Child's			
46. Crocheted			
47. Hand knitted			
48. Machine knitted			
-Man's			
52. Crocheted			
53. Hand knitted			
54. Machine knitted			
55. Knitted			
-Woman's			
40. Crocheted			
41. Hand knitted			
42. Machine knitted			
45. Machine knitted			
-Woman's			
49. Crocheted			
50. Hand knitted			
51. Machine knitted			
- Scarf			
55. Knitted			
56. Crocheted			
-Poncho or Shawl			
57. Crocheted			
58. Knitted			
59. Other			

SECTION 4

Afghans, Bedspreads, and Quilts

Class

-Afghans, Small - Smaller than 48" x 60"	\$4.00	\$3.00	\$2.00
1. Square			
2. Ripple			
3. Stripe			
4. Embroidered			
5. Other			
6. Hand knitted			
7. Machine knitted			
8. Woven			
-Afghans, Medium - Smaller than 60" x 72"	\$5.00	\$4.00	\$3.00
10. Square			
11. Ripple			
12. Stripe			
13. Embroidered			
14. Other			
15. Hand knitted			
16. Machine knitted			
17. Woven			
-Afghans, Large - Larger than 60" x 72"	\$6.00	\$5.00	\$4.00
19. Square			
20. Ripple			
21. Stripe			
22. Embroidered			
23. Other			
24. Hand knitted			
25. Machine knitted			
26. Woven			
Afghans, Baby	\$4.00	\$3.00	\$2.00
28. Ripple			
29. Stripe			
30. Embroidered			
31. Other			
32. Hand knitted			
33. Machine knitted			
34. Woven			

The Great Stoneboro Fair

-Bedspread (minimum 76" x 110")	\$6.00	\$5.00	\$4.00	
36. Crocheted				38. Machine knitted
37. Hand knitted				39. Embroidered
-Quilts, Hand Quilted	\$10.00	\$8.00	\$6.00	
-Applique				
40. Conventional				43. Embroidered
41. Floral				44. Applique
42. Novelty				
-Pieced				
45. Conventional				47. Novelty
46. Floral				48. Tied
-Baby Quilts	\$7.00	\$6.00	\$5.00	
49. Applique				52. Textile painting
50. Embroidered				53. Novelty
51. Pieced				54. Other
-Quilts, Machine Quilted - Pieced	\$8.00	\$6.00	\$5.00	
55. Conventional				57. Novelty
56. Floral				
-Quilts, Whole Cloth	\$8.00	\$6.00	\$5.00	
58. Hand Quilted				60. Machine Quilted professionally
59. Machine Quilted by Exhibitor				61. Embroidered
				62. Lap Quilt (maximum 48" x 48") any fabric or style

SECTION 5 Rugs

Class

-Rug - Small, under 30"	\$8.00	\$7.00	\$6.00	
1. Braided				4. Hooked
2. Crocheted				5. Knitted
3. Felt Applique				8. Woven
-Rug - Medium, 30" to 60"	\$10.00	\$9.00	\$8.00	
9. Braided				13. Knitted
10. Crocheted				14. Knotted
11. Felt Applique				15. Wool Patches
12. Hooked				16. Woven
-Rug - Large, over 60"	\$12.00	\$9.00	\$8.00	
17. Braided				21. Knitted
18. Crocheted				22. Knotted
19. Felt Applique				23. Wool patches
20. Hooked				24. Woven

SECTION 6 SPECIAL CATEGORY

"Dragons, Fairies, and Wizards"

Theme for 2024.....\$6.00 \$5.00 \$4.00

DEPARTMENT 19

Art - Photography - Crafts

SECTION 1

Paintings

1. All entries must be the work of the Exhibitor.
2. All exhibits must be ready to hang.
3. Only one piece in each division of a Class may be entered by each Exhibitor.
4. Youth may enter in Dept. 11, according to guidelines provided in Dept. 11.
5. Art work must have been completed by the Exhibitor since the 2023 Fair.

Class

-Oil and Acrylic	\$9.00	\$7.00	\$5.00
1. Animals or Birds		6. Portrait	
2. Brass or Metal			
3. Display of Fruit		8. Still Life	
4. Flowers		9. Painting on any object	
5. Landscape			
-Watercolors	\$7.00	\$5.00	\$3.00
10. Animals or Birds		13. Landscape	
11. Display of Fruit		14. Portrait	
12. Flowers		15. Still Life	
16. Charcoal	\$7.00	\$5.00	\$3.00
17. Pastel	\$7.00	\$5.00	\$3.00
18. Pen & Ink drawing	\$7.00	\$5.00	\$3.00
19. Pencil drawing	\$7.00	\$3.00	\$2.00
20. Mixed Media	\$7.00	\$5.00	\$3.00
21. Paint by Number	\$5.00	\$3.00	\$2.00

SECTION 2

Photography

DEFINITIONS

- BLACK & WHITE - Only black, white, and grey tones
- LANDSCAPE - Depicting a scene of land or water
- ANIMAL - Domestic animals found as pets or livestock
- WILDLIFE/NATURE - Non-domestic, found in the wild (animals or plants)
- PORTRAITURE - Picture of person or people
- STILL LIFE - Inside picture of inanimate object (no animals - no people)
- ARCHITECTURE - Picture of building, bridge, structure, or part of structure
- DOMESTIC FLOWERS - Garden flowers or house plants
- HUMAN ACTIVITY - Person or people doing something
- COMPUTER ENHANCED - Picture that is completely different from the original - i.e, special effects, pictures pieced together, obvious computer work
- TOUCH OF COLOR - Black & white with one aspect colored.
(Example - black & white picture of a girl holding a rose- rose is colored, remainder is black & white)
- SEPIA - Brown tones, gold tones only

The Great Stoneboro Fair

PHOTOGRAPHY SUBMISSION RULES

1. All entries must be the work of the Exhibitor.
2. All exhibits **must be matted** with total dimensions not to exceed 12" x 14."
3. **NO FRAMES ARE PERMITTED.**
4. Photos must have been taken by the Exhibitor since the 2023 Fair, except photos of the 2023 Fair.
5. A maximum of 6 photographs per Exhibitor will be accepted.
6. Youth between 6 and 18 years of age may enter in Department 11.

Class

-Black and White	\$5.00	\$3.00	\$2.00
1. Landscape			
2. Animals-Domestic			
3. Animals-Wildlife/Nature			
4. Human Activity			
5. Flowers			
6. Stoneboro Fair			
7. Architecture			
8. Portraiture			
9. Still Life			
-Color	\$5.00	\$3.00	\$2.00
10. Landscape			
11. Flowers			
12. Domestic Animals			
13. Wildlife/Nature			
14. Portraiture			
15. Human Activity			
16. Stoneboro Fair			
18. Macro			
19. Architecture			
20. Computer Enhanced			
21. Still Life			
-Sepia	\$5.00	\$3.00	\$2.00
22. Landscape			
24. Domestic Animals			
25. Wildlife			
26. Portraiture			
27. Human Activity			
29. Architecture			
30. Still Life			
32. Touch of Color			
33. Photo of Stoneboro Fair			

SECTION 3

Handcrafts

1. All exhibits must have been made by the Exhibitor; no commercial articles will be accepted.
2. Ceramic articles should have identification marks to indicate they are originals.
3. Only one article or piece in each Class will be accepted.
4. Youth may enter in Dept. 11, according to guidelines provided in Dept. 11.

Class

1. Artificial Floral arrangements	\$6.00	\$5.00	\$4.00
2. Basketry			
3. Scrapbooking - single or double page			
5. Hand-crafted Greeting Cards - set of 6 different designs			
6. Country Painting on everyday objects (not framed art)			
-Ceramics			
7. Glazed			
8. Stained			
9. Free-Hand			
10. Other			
11. Christmas Ornament			
12. Creative Christmas article			
13. Creative holiday item (other than Christmas)			
14. Creative and traditional Dolls—must have extremities			
15. Hand-built or thrown Pottery or Stoneware			

The Great Stoneboro Fair

16. Beadwork
17. Conework
18. Jewelry - handmade
19. Plaster craft
20. Useful Articles
21. Stained glass work
22. Recycled
23. Singular Pot—hand thrown
24. Button Art—must include 10 or more buttons
25. Wood whittling or carving
26. Wood piece- under 12"
27. Wood piece- over 12"
28. Etched Glass work
29. Angels - handmade
30. Wall hanging (other than quilted)
32. Leather work
33. Wreath-natural materials (other than Christmas)
34. Shadow Boxes (no larger than 20"x20")
35. Models
36. Handmade Collection of 5 Soaps—same batch, same size
37. Handmade Lotion
38. Candles-decorative or utilitarian
39. Handmade Soap—1 novelty shape

SECTION 4
SPECIAL CATEGORY

"Dragons, Fairies, and Wizards"

Theme for 2024.....\$6.00 \$5.00 \$4.00



PYMATUNING
MUTUAL FIRE INS. CO.
P.O. Box 232
Mercer, PA 16137
Phone: (724) 269-7227
COVERING YOUR FIRE INSURANCE
NEEDS SINCE 1860
Best Wishes for A Successful Fair!



CHARLES E. DREW
BARBER SHOP
SINCE 1963 - 2024
LAKE STREET
STONEBORO, PA.



THANKS FOR THE MEMORIES!



*Friend of the
Fair
2023*

**Fairboard
President
Shirley
McIntire**

DEPARTMENT 22 SPECIAL CONTESTS

SECTION 301 Miscellaneous Contests BLUE RIBBON APPLE PIE CONTEST

1st - \$15.00 2nd - \$10.00 3rd - \$5.00

RULES for local Fair and the Farm Show contests are as follows:

1. Open to any individual who is a PA resident; only one entry per person.
2. **Entrants may NOT have won 1st place in this Blue Ribbon Apple Pie contest at any other Fair in 2024.**
3. Entry to be a pie that must include at least 60% apples in the filling. It does not need to be a "traditional" two crusted apple pie. It can have a variety of fillings.
4. The entire pie must be submitted for judging in a disposable pie pan. (All pans, plates, dishes are considered to be disposable and will not be returned.)
5. The recipe for the pie and pie crust must be submitted with the entry. It should be submitted on one side of 8 1/2" by 11" paper. The recipe must list all the ingredients, quantities and the preparation instructions. Entrant's name, address and phone number must be printed on the back side of all the pages. (All recipes and pies will become the property of the Fair or PA Farm Show and will not be returned.)
6. Refrigeration is not available at the Fair or PA Farm Show. Entries that require refrigeration after baking must indicate so in the recipe. Those entries will not be sold, auctioned or otherwise distributed for consumption after judging for food safety reasons.
7. Judging will be based on the following criteria:

Flavor	30 points
Filling: consistency, doneness, moistness & flavor	25 points
Crust: color, flavor, texture doneness	20 points
Overall Appearance	15 points
Creativity	10 points
TOTAL	100 points



NOTES:

Creativity is essential to a varied competition. Do not limit your contest to a "traditional" two-crustrd apple pie. We are looking for a variety of fillings in the pies; the pie must include at least 60% apples in the filling. The recipe for the pie and pie crust will also need to be submitted when entering at the PA Farm Show.

Each Fair must sign a Certification Entry Form verifying the winning apple pie baker, and this person will be eligible to enter the state competition at the 2025 Farm Show.

NOTE; If an individual has already won 1st place at another Fair in 2024 for this Blue Ribbon Apple Pie contest, that individual is now considered qualified through that Fair to compete at the 2025 PA Farm Show and is no longer eligible to enter this contest at any upcoming Fairs.

Premiums for the 2025 PA FARM SHOW competition will be as follows:

First Place	\$500.00
Second Place	\$250.00
Third Place	\$100.00
Fourth Place	Rosette Ribbon
Fifth Place	Rosette Ribbon

At the PA FARM SHOW level, this contest is sponsored by:
The Pennsylvania State Association of County Fairs.

MERCER COUNTY ANTIQUE POWER ASSOCIATION

Celebrating Our 32nd Year

SEE US IN 2025

*Featuring
Allis Chalmers
Tractors &
Buda Engines*

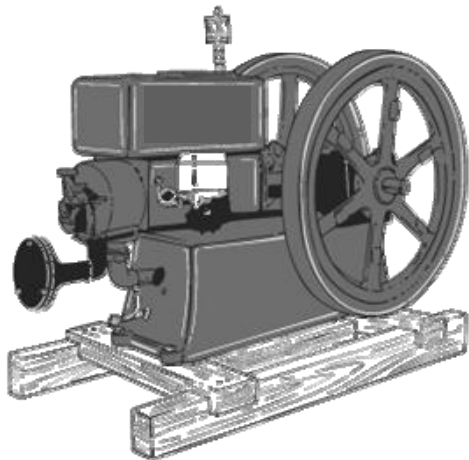

The Great Stoneboro Fair

SECTION 302 20243 HOMEMADE CHOCOLATE CAKE

Sponsored by PA State Association of County Fairs

RULES:

1. Participant must be an individual **amateur** baker who is a Pennsylvania resident: One entry per person.
2. **Entrants may NOT have won 1st, place in this Homemade Chocolate Cake contest at any other fair in 2024.**
3. Entry must be a **layered chocolate cake** made from "scratch." Pre-made mixes are not acceptable ingredients.
4. Entry must be frosted and frosting must be made from "scratch."
5. Cake recipe **must feature chocolate or cocoa** as a main ingredient.
6. The entire cake entry must be submitted for judging **on cardboard or other food safe disposable setting**, (All pans, plates and dishes are considered to be disposable and will not be returned.)
7. Recipes must be submitted with the entry, printed on one side of 8-1/2" x 11" paper. Recipe must list all ingredients, quantities, and the preparation instructions. Entrant's name, address and phone number must be printed on the back side of all the pages. (All recipes and cakes will become the property of the Fair or PA Farm Show and will not be returned.)
8. Refrigeration is not available at the fair or PA Farm Show. Entries that require refrigeration after baking must indicate so in the recipe. Those entries will not be sold, auctioned or otherwise distributed for consumption after judging for food safety reasons.
9. Judging Criteria:

Flavor (aroma, taste, good balance of flavorings)	30 points
Texture (moist and tender crumb; not soggy or dry)	25 points
Inside Characteristics (even grain, evenly baked; free from air pockets)	20 points
Outside Characteristics (consistent shape/size/surface; overall appeal)	15 points
Frosting (taste, texture, even color)	10 points
TOTAL	100 points

PRIZES:	1 st - \$25
	2 nd - \$20
	3 rd - \$15

First Place Winner is eligible for the 2025 PA Farm Show competition.

Premiums for the 2025 Farm Show competition :

First Place \$500 Second Place \$250 Third Place \$100
Fourth Place Rosette Ribbon
Fifth Place Rosette Ribbon

At the PA Farm Show level, this contest will be sponsored by the PA State Association of County Fairs.

SECTION 303
2024 PA PREFERRED JUNIOR BAKING CONTEST
COOKIES, BROWNIES & BARS

The goal of the PA Preferred— Baking Contest is to encourage young people across the Commonwealth to participate in Pennsylvania's Agricultural Fairs by showcasing Pennsylvania grown and produced products in their contest entries.

RULES:

1. Participant must be an individual amateur baker (ages 8 through 18) who is a Pennsylvania resident. One entry per person.
2. **Entrants may NOT have won 1st place in this PA Preferred™ Junior Baking Contest at any other Fair in 2024.**
3. Entry must be a plate of **six (6) individual sized portions** of the baked entry item.
4. Entries must be made from scratch. Premade mixes are not acceptable ingredients. **All ingredients and decorations must be edible.**
5. At least two (2) PA Preferred TM ingredients must be used in the recipe. Some examples of qualifying ingredients are PA Preferred™ grains (such as oats or flour), butter, milk, eggs, fruits and/or vegetables.
6. Entry must be submitted for judging **on a food safe disposable setting**. (All pans, plates and dishes are considered to be disposable and will not be returned)
7. Recipe(s) must be submitted with the entry, printed on one side of 8-1/2" x 11" paper. Recipe must list all ingredients, quantities, and the preparation instructions. The PA Preferred™ ingredients must be listed clearly in the ingredient list, specifying the ingredient and the company that made/grew them (ex: PA Preferred™ Milk - Galliker's brand). Entrant's name, age, address and phone number must be printed on the back side of all the pages. (All recipes and cookies-brownies-bars will become the property of the Fair or PA Farm Show and will not be returned.)
8. **PA Preferred TM logo is not required** because not all PA Preferred TM products carry the label. The name of the ingredient and the source is sufficient. For a list of acceptable products visit papreferred.com. Additionally, PA Preferred TM staff will assist in locating PA Preferred™ ingredients, as needed.
9. Refrigeration is not available at the fair or PA Farm Show. Entries that require refrigeration after baking must indicate so in the recipe. Those entries will not be sold, auctioned or otherwise distributed for consumption after judging for food safety reasons,
10. Judging Criteria:

Flavor	30 points
(aroma, taste, good balance of flavorings)	
Texture	25 points
(appropriate for the type of cookie, brownie or bar)	
Inside Characteristics	20 points
(even grain, evenly baked; free from air pockets)	
Outside Characteristics	15 points
(uniform size, shape, appearance; overall appeal)	
Creativity	10 points
TOTAL	100 points

FAIR PREMIUMS: 1st = \$20 2ND = \$15 3RD = \$10

First Place Winner is eligible for the 2025 PA Farm Show competition,
Premiums for the 2025 PA FARM SHOW competition

First Place • \$500.00 Second Place • \$250.00 Third Place - \$100.00

Fourth Place - Rosette Ribbon Fifth Place - Rosette Ribbon

SPONSOR: PA Preferred™



SECTION 304

ANGEL FOOD CAKE CONTEST RULES

1. Open to any individual amateur baker who is a Pennsylvania resident. One entry per person.
2. Entrants may **NOT** have won 1st place in this Angel Food Cake contest at any other Fair in 2024.
3. Entry must be **an Angel Food Cake** made from "scratch." **All ingredients and decorations must be edible.**
4. **Pennsylvania produced & packed eggs** are requested to be used if at all possible. Please look for the PEQAP or PA Preferred logo or PA packaging dates on the carton.
5. Refrigeration is NOT available at the Fair or PA Farm Show. Entries that require refrigeration after baking must indicate so in the recipe. Those entries will not be sold, auctioned or otherwise distributed for consumption after judging for food safety reasons.
6. The entire cake entry must be submitted for judging **on cardboard or other food safe disposable setting.** (All pans, plates and dishes are considered to be disposable and will not be returned.)
7. Recipe(s) listing the ingredients and the preparation instructions must be submitted with the entry (printed on one-side of 8-1/2" x 11" size paper). Entrant's name, address and phone # must be printed on the back of all the pages. (All recipes and cakes will become the property of the Fair or PA Farm Show and will **not** be returned.)
8. Judging will be based on the following criteria:

Flavor (smell, taste, flavoring)	30 points
Inside Characteristics (texture & lightness)	25 points
Overall Appearance (surface, size, color)	20 points
Creativity	15 points
Topping, Icing or Decoration	10 points

PRIZES: 1st = \$25 2nd = \$15 3rd = \$10

First Place Winner is eligible for the 2025 PA Farm Show competition.

Prizes for the PA State Angel Food Cake Winners:

1st = \$500 2nd = \$250 3rd = \$100

Fourth = Rosette Ribbon Fifth = Rosette Ribbon

At the PA Farm Show level, the sponsors are Pennsylvania's Egg Farmers & PA State Association of County Fairs.

SECTION 305

1. Scarecrow Contest

All scarecrow entries must be between four and five feet tall and have an arm spread from two to four feet. They must be free-standing (Example-mounted on pointed stake in bucket filled with sand or a wooden or metal stand, etc.).

Class

1. Traditional-farm or garden scarecrow made from natural material
2. Non-traditional-of man-made materials
3. Characters-including celebrity look-alikes
4. Era-in-time-from the past, present, or future
5. Ecological-made from recycled materials

AWARDS: 1st - \$25 2nd - \$20 3rd - \$15 4th - \$10

SECTION 306

1. Pumpkin Contest

Rules

1. Entries must have been grown by the Exhibitor.
2. One entry per class by each Exhibitor will be accepted.

Class

- Biggest Pumpkin (by weight)\$7 \$6 \$5
 1. Kindergarten and Under
 2. Grades 1-6
 3. Grades 7-12
- Best Natural Pumpkin (degree of perfection)\$4 \$3 \$2
 4. Kindergarten and Under
 5. Grades 1-6
 6. Grades 7-12
- Best Jack-O-Lantern (Uncut-painted)
 7. Kindergarten and Under
 8. Grades 1-6
 9. Grades 7-12
- Most Unusual Shape
 10. Kindergarten and Under
 11. Grades 1-6
 12. Grades 7-12
- Dress up Pumpkin
 13. Kindergarten and Under
 14. Grades 1-6
 15. Grades 7-12

Grand Champion (Heaviest) \$50 Cash Prize - Youth Only
Reserve Grand Champion (Heaviest) \$25 Cash Prize - Youth Only

DEPARTMENT 23

Apiary and Maple Products

SECTION 1

Bees, Honey, Beeswax

Class 1 will be judged on uniformity of color, bees, presence of queen, brood and honey, and cleanliness and appearance of the observation hive. Comb honey will be judged on perfection in filling, capping, uniformity, neatness, and cleanliness of section. Extracted honey will be judged on body, clarity, and cleanliness. Beeswax will be judged on color and purity.

Class

1. Bees, any race\$10.00 \$8.00 \$6.00

Any observation hive

- Honey \$5.00 \$4.00 \$3.00

2. Light comb, 3 sections
3. Dark comb, 3 sections
4. Light extracted honey, 1 - one pound jar
5. Amber extracted honey, 1 - one pound jar
6. Dark extracted honey, 1 - one pound jar
7. Finely crystallized honey, 1 - one pound jar
8. Beeswax (not less than one pound)
9. Display of or exhibit of honey products

SECTION 2

Maple Syrup and Maple Products

1. Competing exhibits will be made by the Exhibitors.
2. One exhibit may be entered in each class.
3. Syrup will be judged on flavor, color, density, and clarity.
4. Sugar will be judged on flavor, appearance, and texture.

Class

1. Maple Syrup, one quart container \$5.00 \$4.00 \$3.00
2. Maple Syrup, one pound \$5.00 \$4.00 \$3.00
3. Maple Cream, one pound..... \$5.00 \$4.00 \$3.00
4. Maple Sugar, soft small individual
cakes, not less than one pound..... \$5.00 \$4.00 \$3.00
5. Collective Exhibit, corresponding
to the above classes\$9.00 \$7.00 \$5.00

STONEBORO FAIRGROUNDS

WINTER STORAGE AVAILABLE

OCTOBER—APRIL

Phone: 724-699-0797

**WIMER
FUEL
INJECTION &
TURBO LLC**

1614 Georgetown Rd.
Sandy Lake, PA 16145
(724) 376-2904

www.wimerfuelinjection.com

**New and Rebuilt
Pumps, Injectors,
and Turbos**

*Hours:
Monday - Friday: 8:30 - 5:00*



GingerSnap Junction

Resale Shop

GIFTS * COLLECTIBLES * ANTIQUES * VINTAGE

Open Year Round

Thursday, Friday, Saturday, & Sunday 10AM - 4PM
Closed Monday, Tuesday & Wednesday

5 MILES NORTH OF SANDY LAKE ON RTE 173

like us on Facebook gingersnap173@zoominternet.net

4273 MERCER STREET, SANDY LAKE, PA 16145 (724)376-7058

S
SANDY
L
LAKE
M
MILLS



FEED • HARDWARE • MULCH
WOOD PELLETS • PROPANE
• AND A WHOLE LOT MORE!

26 Mill Street
Sandy Lake, PA 16145

Brian J. Raymond
724/376-3085

Hours
Tues-Fri 9-6
Sat 9-1
Sun-Mon Closed

J & J SAUER

**SOUTHERN AUTO PARTS
& SALES**



Route 358 - Sandy Lake, PA
3 miles east of I-79
(724) 376-2768

A decorative border with a central hanging bunch of grapes and grapevines with leaves on the sides. The border is ornate and frames the text.

JB'S RETREAT
1520 FRANKLIN ROAD (ROUTE 62)
JACKSON CENTER, PA 16133
WWW.JBSRETREAT.COM
INFO@JBSRETREAT.COM
BRING YOUR FRIENDS, PROJECTS, AND A PAIR OF SLIPPERS AND
GET STARTED!
724-712-3222 JO 412-612-7482 JANET

WE'VE GOT YOU COVERED WITH THE AREA'S BEST INTERNET!



Zoom Internet with Enhanced Wi-Fi constantly learns about your internet needs, and optimizes your network for fast and reliable internet where and when you need it most!



Whole Home Coverage



Security Evolved



You're in control with the app



Unlimited data

Proud to support



ARMSTRONG®

ArmstrongOneWire.com
1.877.277.5711





SALES ~ SERVICE ~ INSTALLATION
Located One Mile North of the Courthouse Rt. 62, Mercer

Josh Heckman
Owner

McCLUNG *Auto Body*

Computerized Color Matching
Guaranteed Repairs
4 Wheel Alignment

Two Bench Frame Machines
Rental Cars Available on Site
Air Bag Diagnostics & Service

The Areas only Gold Class Repair Facility.



688 Bradley Road
(Hendersonville)
Stoneboro, PA 16153



Phone (814) 786-9744 or (724) 376-2142

HILLMAR AUCTION SERVICE



Beth Hillmar
989 East Cornell Road
Mercer, PA 16137

Phone:
(724) 967-4039

PATTERSON SEPTIC SERVICE



Mark Patterson

Goulds Pump Dealer

Septic Tanks Cleaned
Sandmound Pumps Replaced
Sandmound Jetting
& Minor Repairs

BOX 101
JACKSON CENTER, PA 16133

1-800-988-0688

1-724-662-3996

1-814-786-7945

www.pattersonseptic.com

info@pattersonseptic.com

Have a Great Fair!

*Best wishes for another
great fair!*



Thomas J. Kosick
General Dentistry

“Filling” all your family’s dental needs!

- cleaning exams
- fillings
- crowns and bridges
- root canals
- extractions
- denture and partials
- and more!

Hours: Mon, Tues, Thurs / 8 - 4:30
Wed / 8 - 6
Emergencies - Always

most commercial insurances accepted.
visa, mastercard, and discover.

Thomas Kosick DMD - 36 Branch Street - Stoneboro, PA 16153
Phone: 724-376-2004 - www.facebook.com/kosickdmd

*"Have Fun at the
Stoneboro Fair!"*



**Michele
Brooks**
State Senator
50th District



Paid for by People to Elect Brooks

***Grantham's
Landing***



GOOD FOOD – PLEASANT ATMOSPHERE
Hours: Tuesday - Sunday (7AM - 8PM)

**Rt 173 - NORTH
SANDY LAKE, PA 16145
(724)376-3244**



Entry Day for Fine Arts and Rabbits ONLY

Will be Tuesday, August 27th
From 8 AM – 8 PM.

Departments 9, 17, 18, 19 & Dept. 11
(Section 2-6)

Spiegel's Flooring

*We make it EASY to say
YES to new flooring!*

Right Downtown Sandy Lake, PA
(stop by and see our new showroom)
www.spiegelflooring.com

Quillen's Café LLC

1151 Walnut Street
Stoneboro, PA

“Best Sandwiches in Town”
♦ Cold Beer ♦ Taco Tuesday ♦
Wings Wednesday and Sunday!

Stop in during “Fair Time” or Anytime.

Hours:

Tuesday—Saturday 11 AM—2 AM

Sunday 12 Noon—12 Midnight

Closed Monday

(724) 376-2823

Check out Music at
Bedford Grange Mutual Insurance
Centerfield Pavilion



***Enjoy some good music
and picnic table seating!***

Show Times and Groups
Listed in Fair Schedule

**JANE'S
STROMBOLI**

Stoneboro, PA 16153

Fundraising • Retail • Wholesale

Store: 724-376-3828 Toll Free: 1-888-376-3828

Home: 814-786-9733



ROSE AND BLACK

FUNERAL HOME & CREMATORY, INC.

Stoneboro & Sandy Lake

99 Franklin Street

3236 S. Main Street

Stoneboro, PA 16153

Sandy Lake, PA 16145

Scott A. Black, FD, Supvr Robert S. Waid, FD, Supvr

Casey W. Rose, FD

(724) 376-4000

www.RoseAndBlackFH.com

BUY, SELL, TRADE PAYING TOP DOLLAR FOR USED GUNS

- Like/follow us on Facebook for most updated inventory and Info!
- You can also find us on Twitter and Instagram!



GRIFFIN ARMS

Cash and Military/Law Enforcement discounts with proper ID!!

4581 Greenville Sandy Lake Rd.
Stoneboro, PA 16153
724-376-2757
www.griffinarms.net
1 mile east of I-79 on Rt. 358

Free PICS
(Background) check
when you bring this ad
on your next firearm
purchase!!

In memory of
Quinn & Ingle Burnett
Greenville, PA

Compliments of
Doug & Jeannie Greenfield



MATERIALS, INC.
Washed Sand & Gravel
www.hhmaterialsinc.com
190 Canon Road, Stoneboro, PA 16153
Phone 724/376-2834
Plant Location: Exit 130 off I-79
East Route 358 to First Road on Right
Follow Signs approximately 1 Mile.

McDowell
IMPLEMENT COMPANY, INC.
SERVICE ~ PARTS

On Route 173 - 1 mile North off - 80 Exit
814-786-7955 www.mcdowellimplement.com
Grove City, PA



New Holland Farm Equipment
H & S
Wood Cutters

Rissler Feed Carts
Kuhn

*SEE OUR DISPLAY AT THE FAIR.
Financing & Leasing Available*



TRIM &
CLEAN UP

D.PATTS LAWN CARE

S E R V I C E S

Residential & Commercial

Not looking forward to mowing your own lawn and doing spring cleaning, don't be afraid to give us a call you won't be disappointed after all!

OUR AWESOME SERVICES

- ✓ Mowing
- ✓ trimming
- ✓ lawn rolling
- ✓ spring clean ups
- ✓ leaf clean ups

 (724)456-5415

 pattersondanny90@gmail.com

D.Patts
Lawn care

(724)456-5415



YELLOW CREEK INN

1171 Franklin Rd
Jackson Center, PA 16133

(724) 662-2339



INSURANCE AGENCY
SINCE 1922

AWL&L

Tarentum Location:
201 Corbet Street, Suite 3
Tarentum, PA 15084

P: 724-224-0550

F: 724-224-2371

Sloan Insurance

Apollo Location:
108 North Plaza
Apollo, PA 15613

P: 724-478-3113

F: 724-478-2220

Montgomery Insurance

Sandy Lake Location:
3302 N. Main Street
Sandy Lake, PA 16145

P: 724-478-3113

F: 724-478-376-2031

Tomlinson Agency

Oakmont Location:
506 Allegheny River Blvd.
Oakmont, PA 15139

P: 412-828-3393

F: 412-828-3393

Westmoreland Ins. Serv.

New Kensington:
2400 Leechburg Road, Suite 206
New Kensington, PA 15068

P: 724-337-3557

www.alli-ins.com



- Fire Extinguisher Sales/Service
- Emergency Lighting Sales/Service
- First Aid Sales/Service
- Fire Extinguisher, First Aid & CPR/AED Training
- Sprinkler/Backflow Inspections



Saeleer
Construction & Remodeling, Inc
Custom Homes & Remodeling Since 2001

SAELERCONSTRUCTION@HOTMAIL.COM Office: (724) 748-9155
PAHIC #034069 Mobile: (724) 866-6068

Jeff
Reddick
ROLL-OFFS
& HAULING
STONEBORO, PA
724 ▾ 376 ▾ 2261

Dumpster Rentals

5 thru 35 yard
roll-off containers

CONSTRUCTION DEMOLITION
REMODELING ROOFING
GENERAL CLEANUP
COMMERCIAL/RESIDENTIAL

Dumpsters with Dependability

Quality Firewood

18" Cut Slabs or Blocks,
Random Lengths
4+ Full Cords

www.jeffreddickrolloffs.com



Braham Auctions

Three Generations Since 1949

Donald Braham
724-992-0061

Dylan Braham
724-372-0731

Live and Online Auctions
BrahamAuctionsPA@gmail.com
www.BrahamAuctions.Hibid.com

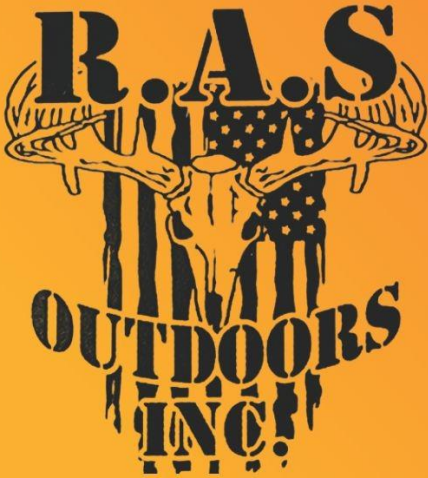

- Custom Built Hunting Shanties
- Food Plots
- Brush Hogging & Tilling Services
- Family Tradition Tree Stands

724-814-4395

315 Saxonburg Blvd.
Saxonburg, PA 16056

www.RASOutdoorsInc.com

Kress Auto Center



**Diagnostic Auto Repair
"24 Hour Towing & Road Service"**



**33 Franklin Road
Mercer, PA 16137**

**DAVID KRESS
Owner**

**Phone: (724) 662-2631
(724) 866-7346
kressautocenter.com**



INTERSTAE SELF ★ STORAGE

Located at Exit 121, Off of I-79

724-662-1186
(Across from the State Police Barracks)

- ★ Secure Household & Commercial
- ★ Discount On Long-Term Leases
- ★ 24 Hour, 7 Day Access



We Accept All Credit Cards

OFFICE HOURS
MONDAY-FRIDAY
9:00AM-5:00PM
SATURDAY
9:00AM-NOON

McCartney's Feed Mill and Hardware



Dealers in
FEED • GRAIN • FERTILIZERS • SEEDS
• ANIMAL HEALTH PRODUCTS
• HARDWARE

Custom Grinding and Mixing

724-475-3215



Minor Acres Packing Company

Kilgore Rd.
Jackson Center, PA
814-786-7852

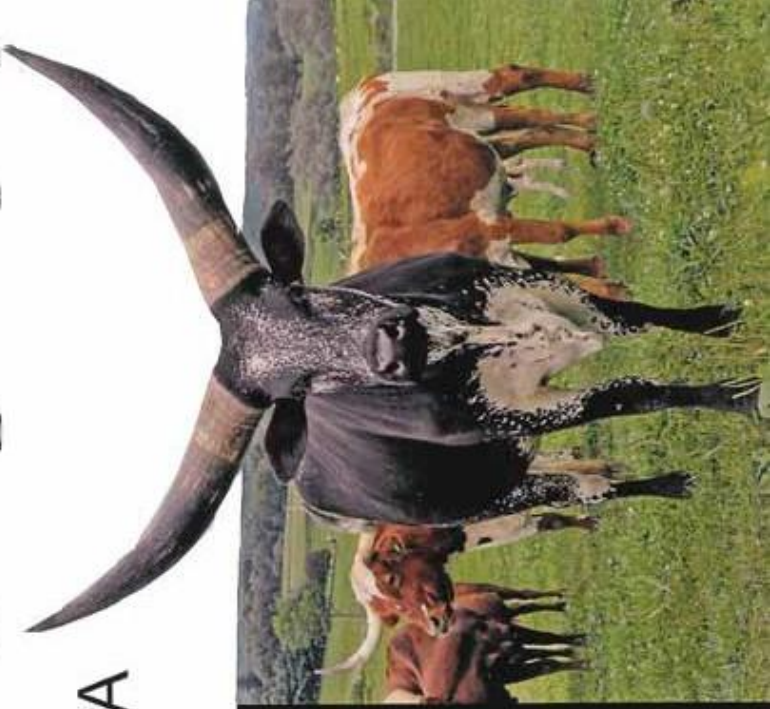

**Custom
Slaughtering
We Cut,
Wrap, and
Freeze**

**Bob Minor,
Proprietor**

Newton Financial Services

Harold P. Newton, Jr. E.A.
hnewtonjr@gmail.com



Isaiah 40:31

Office: 724.269.9442

Fax: 724.269.9444

Web: newtonfinancialservicesllc.com

112 Timber Village Lane
Mercer, Pennsylvania 16137

Meadville Floors

**16697 Conneaut Lake Road
Meadville, PA 16335
(814) 333-9486
Fax (814) 337-8496**

**Hours: MON-FRI 9-5
SAT 10-2**

**HARDWOOD
CARPET • VINYL
CERAMIC • TILE • AREA
RUGS**

**Clay Marsteller - Owner
Travis Marsteller - Owner**

BEN BISSETT CHEVROLET

MERCER COUNTY'S TRUCK HEADQUARTERS

WWW.BISSETTCHEVY.COM



**ALL-NEW
2024 CHEVROLET TRAX**

**CHEVROLET
SILVERADO ZR2**



**ALL-NEW
CHEVROLET COLORADO**



**STOP AND SEE US OUR DISPLAY
IN THE INFIELD**

Clapper Insurance
Stoneboro, PA
724-293-0094

Stop baaa for a quote on your
insurance

You could save mooooooore.

AGENT FOR
GOODVILLE
MUTUAL

Good luck for a successful 2024 fair



Please support your local fire department, become a volunteer.

The Great Stoneboro Fair

THANK YOU TO ALL OUR SPONSORS FOR MAKING OUR FAIR GREAT!

DIAMOND SPONSOR

MERCER COUNTY STATE BANK

ARMSTRONG CABLE

PLATINUM SPONSOR

FLEXOSPAN STEEL BUILDINGS, INC.

PRUSKOWSKI TRUCKING

DEV'S SAILORS MARKET

LYNCHWOODS SPIRITS

WILSON ELECTRIC, INC.

GOLD SPONSOR

PA. LOTTERY

VISIT MERCER COUNTY PA.

MCOVERHEAD DOORS, INC.

KRISTYAK'S KORNER

MCCULLOUGH GRAIN

CLAPPER INSURANCE AGENCY, INC.

SILVER SPONSOR

BEDFORD GRANGE MUTUAL INSURANCE

GROVE CITY FEDERAL CREDIT UNION

CTC PACKAGING

BRONZE SPONSOR

HECKMAN DIVERSIFIED

Z & B STORAGE

NEXTIER BANK

PYMATUNING INSURANCE

MONROE TRACTORS



Feel right at home.

When you feel at home,
everything feels right.
And that frame of mind
can begin the moment
you arrive home with an
upgrade to your garage
or front door from Plyler.

Visit us at PlylerEntry.com
or at one of our three
showrooms for a free estimate.



PLYLER ENTRY SYSTEMS

Erie
8850 Fry Road
McKean, PA 16426
814-476-7717

Hadley
2357 Perry Highway
Hadley, PA 16130
724-253-3564

Jamestown
1884 Mason Drive
Jamestown, NY 14701
716-296-0595

*Farm
Friendly*



**• HARDWOOD LUMBER WANTED
IN COCHRANTON, PA**

4/4 Hardwood	Looking for Green Saw Dust
Pallet Lumber	Delivered 100
& Hardwood	Yard Walking
Blocking	Floor Loads
Logs & Poles	Available

Call Scott	Call John	Call David
814-425-2500	814-795-1326	814-425-2500
Ext 242		Ext 221

• FRESH BARK AVAILABLE

CamperS ~ RV'S ~ Motor Homes
Cars ~ Tractors ~ Boats
Inside or Outside

Z&B STORAGE

864 N. Perry Highway Mercer, PA 16137

Tim Burton 724-699-4373 Bill Doyle 724-679-8259
MAJORDOMO



1-800-891-4230
Almost Instant Service

814-768-7545
140 Bestwick Road, Jackson Center, PA 16133

SERVING
THE GREAT STONEBORO FAIR
FOR 38 YEARS

Commercial, Industrial,
and Residential Wiring

Pole Setting
Fully Insured

Bucket Truck Service
Free Estimates

PA HIC #192
SEE US AT THE GREAT STONEBORO FAIR
BY THE MIDWAY TUNNEL
IN THE INFIELD



Find us on
Facebook

or online at CustomCornerPrinting.com
e-mail: info@CustomCornerPrinting.com

CustomCorner Printing



275 Main Street
Greenville, PA 16125

(724) 588-1667

ENVELOPES

NEWSLETTERS

BLUEPRINTS

MAILERS

LETTERHEADS

BUSINESS

FORMS

LAMINATING

BUSINESS

CARDS

RUBBER

STAMPS

BOOKLETS

CARBONLESS

FORMS

LABELS

PLUS
Screenprinting • Embroidery
Copies • Shipping



FedEx
Authorized
ShipCenter



Lakeview Area
PUBLIC LIBRARY

lakeviewarealibrary.org
724-376-4217

**Offering a family-oriented,
community center providing
resources for all ages!**

Supported by and Serving
the Lakeview Community!

Books ~ ebooks
Audio Books
DVD's
Free Wi-Fi
Computers
Ancestry
Preschool Storytime
Book Club
Chess Club
Knitting Club
Reading Challenges

3265 S. Main Street
P.O. Box 622
Sandy Lake, PA
Copy and Fax Services



**COMMERCIAL - INDUSTRIAL
METAL ROOFING AND SIDING**

SANDY LAKE, PA.

800-245-0396

WWW.FLEXOSPAN.COM

*** WBENC Certified Women-Owned Small Business ***

LAUBSCHER



CHEESE COMPANY^{INC.}

CHEESE DISTRIBUTORS

1468 N. PERRY HIGHWAY
MERCER, PA

Phone 724-475-4015

-All Types of Cheese-
Imported • Domestic



OVER 40 FLAVORS OF MOONSHINE

BOURBON

WHISKEY

RUM

PICKLES

ICE CREAM • FRUIT • SLUSHIES



1905 MERCER ROAD JACKSON CENTER, PA

WWW.LYNCHWOODSSPIRITS.COM

MONDAY - FRIDAY 10-8 SATURDAY 10 - 5



*We appreciate the friendship
and loyalty that has been
given over the past 70 years.
Here's to 70 more!*

724-376-2489

3675 Sandy Lake Rd ♦ Sandy Lake PA ♦ www.sandylakeimp.com

PENN VALLEY
SHOWS LLC.
Middleburg P.A.



Come see **THE BEAST**
At the Fair!



8392 Sharon-Mercer Road • Mercer, PA 16137

HOWARD & SON MEATPACKING

HOME OF D.J.'S SMOKEHOUSE

724-662-3700

USDA INSPECTED

An advertisement for 'Auto Refinishers' set against a black background with a green hexagonal pattern and blue splatters. The central focus is a stylized illustration of a paint gun with a blue handle and a silver nozzle, and a pair of goggles with green mesh lenses. The text 'Auto Refinishers' is written in large, bold, blue letters with a white outline and a drop shadow. To the right of the central image, the services 'COLLISION REPAIR AND REFINISH' and 'PAINTLESS DENT REMOVAL' are listed in white, bold, italicized capital letters. At the bottom, the address '1905 MERCER ROAD JACKSON CENTER' and the phone number '724-376-3404' are provided in white and green text.

**COLLISION REPAIR
AND REFINISH**

**PAINTLESS DENT
REMOVAL**

AUTO REFINISHERS

1905 MERCER ROAD JACKSON CENTER
724-376-3404

**Dev's
Sailors
Market**

724.376.4563

4:30 AM - 12:00 AM

**2436 MERCER STREET
STONEBORO, PA**



724.376.4062

7:00 AM - 10:00 PM



Pepperoni Rolls - Sausage Rolls -
Philly Steak - Spicy Chicken Subs
Pizza ...& More

**Fresh Clarks Donuts Daily *Howe's Coffee*
*Hershey's Ice Cream *F'Real Milkshakes*

3294 North Main St
Sandy Lake, PA
724-376-3548

Convenience Store & Gas Station

PA Lottery
Live Bait Vending Machine
ATM Inside
Greeting Cards Available
PA Skills Games

FRIED CHICKEN TO GO!



Banking *but* Better



Federally insured by NCUA

MIJAVEC'S CATERING

Catering for ALL occasions!



Call
(330) 219-0588

The Great Stoneboro Fair



Investing in the *Community* to make a difference.



Kayla M. Armstrong
Grove City Branch Manager
724.264.4145 (Office)
karmstrong@nexttierbank.com

Our Grove City team members work together to assist and provide sound banking advice to individuals, families, and businesses throughout Mercer and northern Butler counties.

Kayla is a dedicated Banker with lifelong roots in Mercer County, growing up in Grove City and the Lakeview School District. She attended Robert Morris University where she developed a passion for the Alzheimer's Association. Kayla actively supports various veteran groups in honor of her family's military service, and is involved in many youth sporting organizations with her children.



Visit Us At:

109 S. Broad Street, Grove City, PA 16127
1.800.262.1088 | www.nexttierbank.com

Member
FDIC

**Lakeview Area
Community Church
1472 School Rd.
Sandy Lake**

**Hendersonville Church
1013 Jackson Center -
Polk Rd.
Stoneboro**



**Unity of Faith
32 Lake St.
Stoneboro**



**Vincent New Beginnings
28 Walnut St.
Jackson Center**

FAIRVIEW SWISS CHEESE



Proud to Introduce Our New Cheese:
GRAN OPAGGIO

Supporting Local
 Dairy Farms Everyday!



1734 Perry Highway
 Fredonia, Pennsylvania

John Koller & Son Inc.
 724-475-4154
 FairviewSwissCheese.com



**THE EXCLUSIVE DEALER FOR
FREIGHTLINER & WESTERN STAR
IN NORTHWESTERN PA**

**Your one-stop shop for:
Parts • Service • Sales**

Open M-F
7:30am-6pm



COME CHECK US OUT!



**Congratulations to the
Great Stoneboro Fair
on 156 years!**

5758 State Route 8
Harrisville, PA 16038

BARKEYVILLE

814-786-8009

www.fydafreightliner.com

The Great Stoneboro Fair

2024

PENNSYLVANIA DEPARTMENT OF AGRICULTURE

ANIMAL HEALTH REQUIREMENTS AND RECOMMENDATIONS FOR ANIMAL EXHIBITION, INCLUDING COMMERCIAL EXHIBITION

SUBCHAPTER A: GENERAL INFORMATION SECTION

1. Background: This document provides the Pennsylvania Department of Agriculture's (Department) animal health requirements and recommendations for all animal exhibitions (shows) in the Commonwealth, including Pennsylvania county and community fairs. This document is divided into Requirements and Recommendations for both Pennsylvania animals and animals arriving from out of state for each species. The Requirements listed in this document are mandated by law. The legal basis for these recommendations can be found at the end of the document in Subchapter D. Recommendations are not legally mandated but are based on best practices and the scientific judgement of the state animal health officials. Fairs are strongly encouraged to adopt these recommendations. Fairs may impose more stringent rules than the requirements in this document at their own discretion. All exhibitors are encouraged to check with the management of each fair in advance to ensure compliance with all fair requirements. While this document is designed for organizations receiving funding through the Pennsylvania Agricultural Fair Act (act of July 8, 1986, P.L. 437, No. 92)(3 P.S. §§ 1501- 1510), this document serves as a reference for all animal exhibits as defined in the Animal Exhibition Sanitation Act (3 Pa.C.S. §§ 2501-2504). These requirements and recommendations are a shared responsibility of show management and exhibitors to protect public and animal health in the Commonwealth.

2. Important information regarding poultry exhibition cancellations: Due to Highly Pathogenic Avian Influenza (HPAI) detections in the Commonwealth, a signed General Quarantine order went into effect on April 16th, 2022. The order, titled 52 Pa. B 2223 General Quarantine Order; Cancellation of Exhibition of Poultry and Their Hatching Eggs Due to Highly Pathogenic Avian Influenza, prohibits the display, exhibit, or presence of poultry, poultry products, including eggs, poultry parts or any goods or items containing or made up of poultry products such as feathers, or poultry parts at any exhibitions or other such venues within the Commonwealth of Pennsylvania which receive funding pursuant to the Pennsylvania Agricultural Fair Act 3 P.S. § 1501 et seq.

The quarantine order does not prohibit a fairgrounds from leasing the facilities for a private poultry show. Although this is not prohibited by the order, it is discouraged, especially in poultry-dense areas such as Lancaster, Lebanon, Chester, and Adams, York, Lehigh, Berks, Snyder, Northumberland, Juniata, and Union counties, or in any location near a commercial poultry facility. If avian influenza was identified in a bird that was at one of these private shows, the tracebacks would be extensive and could result in many flocks being quarantined and possibly infected. The fairgrounds would also have to be quarantined pending virus elimination on the grounds. For private events that do not meet the definition of "Animal Exhibition" under the Animal Exhibition Sanitation Act, pre-entry testing for avian influenza, continuous health monitoring of the birds, and stringent biosecurity protocols are recommended. Records of entries should be retained for two years and made available to the Department upon request if needed for traceability.

No poultry exhibitions regardless of their funding, association, or venue may occur within a 10 km control zone of a premises infected with Highly Pathogenic Avian Influenza pursuant to Pa. B. 2597 General Quarantine Order, Virus Control for Highly Pathogenic Avian Influenza Poultry, Poultry

The Great Stoneboro Fair

Litter, Conveyances, Feed, Refuse, Containers, and Material Standards, published Saturday April 30th, 2022. Current control zone proximity may be checked at the Department's Control Zone Address Checker on the Pennsylvania Animal Diagnostic Laboratory System (PADLS) website by clicking on the following link: [Highly Pathogenic Avian Influenza \(arcgis.com\)](https://padeptag.maps.arcgis.com/apps/webappviewer/index.html?id=a9066a3d68a443a08043766cb84bf4ae) or by typing directly in the search bar:

<https://padeptag.maps.arcgis.com/apps/webappviewer/index.html?id=a9066a3d68a443a08043766cb84bf4ae>.

3. Changes for poultry and poultry products in 2024: These 2024 *Animal Health Requirements and Recommendations for Animal Exhibition, Including Commercial*

Exhibition, will reference the April 16, 2022 General Quarantine Order; Cancellation of Exhibition of Poultry and Their Hatching Eggs Due to Highly Pathogenic Avian Influenza or its successor Order, which may allow for limited exhibition of poultry and poultry products at venues that receive funding pursuant to the Pennsylvania Agricultural Fair Act referenced above, provided that the Department has determined that there are currently no active HPAI control areas or surveillance zones in place in Pennsylvania.

If there are currently no active HPAI control areas or surveillance zones in place in Pennsylvania, the exhibition of market poultry which will be moved directly to slaughter, unfertilized eggs, and ornamental feathers may be allowed, at the Department's discretion. The Department will provide notification to fair managers if any active HPAI control areas or surveillance zones are in place in Pennsylvania at the beginning of the 2024 fair season and will provide updates throughout the season as necessary. The placement of a HPAI control area or surveillance zone in Pennsylvania will result in the immediate reinstatement of the prohibition of exhibition for all poultry and all poultry products.

4. Exhibition of arts and crafts using poultry feathers may be allowed at the Department's discretion. The Department will provide notification to fair managers before the 2024 fair season begins and will provide any updates as necessary throughout the season as necessary. Poultry feathers, including shafts and down, may be allowed for arts and crafts at exhibitions if they meet the following requirements:

- (a) Shall be sourced and packaged in the United States or meet United States Department of Agriculture (USDA) import requirements.
- (b) Shall be washed or steam-treated and dried before packaging.

5. **Certificate of Veterinary Inspection (CVI).** This is an official document issued by a federal, state, tribal, or accredited veterinarian certifying that the animals identified on the document have been inspected and were found to satisfy the regulations pertaining to their intended movement—*within the same state, between states, or internationally.*

- (a) CVIs are required for all swine, both from out-of-state and from in-state, and out-of-state camelids, cattle, cervids, equines, goats, sheep, and rabbits. For in-state camelids, cattle, cervids, equines, goats, sheep, and rabbits, these guidelines list a CVI as recommended. A CVI serves as verification of animal ID, an attestation of health, an attestation of a Veterinarian-client-patient-relationship (VCPR), and documentation of applicable vaccination and testing.

The Great Stoneboro Fair

- (b) The parameters for a CVI are included under the standards for veterinary accreditation, which are set by the USDA and are in the Code of Federal Regulations (CFR), which can be referenced at the following link: [eCFR: 9 CFR 161.4 -- Standards for accredited veterinarian duties](#).
- (i) Per the CFR, a veterinarian may write a CVI if they have *examined an animal within the last 10 days* (unless the veterinarian is doing qualifying regular herd/flock checks; see the CFR for details.)
 - (ii) **Per the CFR, once a veterinarian issues a CVI, the CVI expires after 30 days.**
 - (iii) A CVI should be written for only one destination. However, multiple CVIs (one for each destination) can be written within 10 days after the inspection/examination of the animals.
 - (iv) CVIs issued by an accredited veterinarian are legal documents and shall only be issued if the animal is not showing clinical evidence compatible with the presence of a communicable disease upon inspection and/or examination.
 - (v) A copy of the CVI is provided to the owner, and the appropriate remaining CVI paper copies, regardless of if they are completed for interstate or intrastate movement, must be submitted to the Pennsylvania Department of Agriculture Bureau of Animal Health at 2301 N. Cameron St. Harrisburg, PA 17110. Alternatively, electronic CVIs may be used.
- (c) An accredited veterinarian may not complete a CVI that does not meet USDA standards.
- (d) A Veterinarian-client-patient-relationship (VCPR) form may be used to verify animal ID and provide an attestation of a VCPR. VCPR forms do not have the 30-day expiration that is federally mandated for CVIs.
- (e) All swine for exhibition must be accompanied by a CVI that was issued by a licensed and accredited veterinarian within the 30 days prior to the date of the animal exhibition.

6. Verification of Veterinarian-client-patient-relationship (VCPR): The Animal Exhibition Sanitation Law requires attestation that a VCPR exists for **all animals** to be exhibited. This attestation states that the owner or caretaker of the animal has assumed responsibility to consult a veterinarian and has agreed to follow the instructions of the veterinarian in relation to animal diseases and implementing best management practices intended to reduce and prevent disease. This requirement can be fulfilled by any of the following means:

- (a) A Veterinarian-client-patient-relationship (VCPR) form with a veterinarian's signature (see Subchapter D).
- (b) A statement for the animal(s) being exhibited with a signature of the owner or caretaker on the fair registration form: "I attest and affirm that a "VCPR" exists with regard to any animals I will be exhibiting." (This statement does not replace the Owner Endorsed Avian Health Certificate and Biosecurity Statement or a CVI where required).

The Great Stoneboro Fair

- (c) A valid CVI.
- (d) For poultry and poultry products, this requirement may be fulfilled by the Owner Endorsed Avian Health Certificate and Biosecurity Statement (see Subchapter D).

- 7. Owner Endorsed Avian Health Certificate and Biosecurity Statement—Poultry:** For allowed market poultry, unfertilized eggs, and ornamental feathers being exhibited, a completed Owner Endorsed Avian Health Certificate and Biosecurity Statement must accompany the market birds, eggs, or feathers for entry into the exhibition premises. This is an official form provided by the Pennsylvania Department of Agriculture.
- 8. Other recommendations for exhibitors:** The Department strongly recommends that animals returning home from exhibitions be isolated from other members of the herd or flock for a minimum of three weeks to help prevent the spread of disease and recommends that exhibitors of all animals discuss the health of their animals, including vaccine recommendations and other preventative measures, with a veterinarian on a regular basis. Owners and their veterinarians should carefully check and comply with additional requirements specific to each exhibition prior to the exhibition to ensure eligibility. The Department also encourages livestock and poultry owners to register their premises with the Department so they can be contacted in a disease emergency situation. Call 717-787-4172 to register a premises.
- 9. Reporting of suspected dangerous transmissible diseases:** Please call the Department immediately to report any suspicions of diseases such as avian influenza, foot and mouth disease, African swine fever, and other transmissible diseases. The contact number is: **717772-2852**, option 1, 24 hours per day, 7 days per week. Reporting of signs and symptoms that are consistent with a dangerous transmissible disease is legally required by the Domestic Animal Law (3 Pa.C.S. § 2327).
- 10. Interstate and intrastate movement of domestic animals:** It is illegal, under section 2323 (related to health requirements) of the Domestic Animal Law, to "...knowingly, recklessly or negligently import or bring into this Commonwealth without written permission of the department any domestic animal that is contaminated with a hazardous substance or that is infected with or that has been exposed to any transmissible disease...or bring into this Commonwealth any domestic animal in violation of any of the provisions of [the Domestic Animal Law], an order entered under the authority of [the Domestic Animal Law] or an attendant regulation to prevent the introduction of any transmissible disease...or have in his keeping or possession any domestic animal imported, brought into or transported within this Commonwealth in violation of any of the provisions of [the Domestic Animal Law] or to allow any such domestic animal to come into contact with any other domestic animal." (3 Pa.C.S. § 2323(a) and (b)).
- 11. Biosecurity guidelines:** It is recommended that Exhibition Managers follow the *Biosecurity Guidelines for Exhibition Managers*, included in Subchapter D, and provide exhibitors with a copy of *Keeping Your Show Animals Healthy-Biosecurity Guidelines for Exhibitors*, included in Subchapter D.

SUBCHAPTER B:

ADDITIONAL REQUIREMENTS FOR THE PENNSYLVANIA FARM SHOW COMPLEX

The Great Stoneboro Fair

- 1. Rabies vaccination requirements:** There are rabies vaccination requirements for vaccineeligible animals exhibited at the Pennsylvania Farm Show Complex ("complex"). For all animal exhibition events held at the complex, animal species for which a rabies vaccine is labeled for use shall be vaccinated prior to exhibition in the complex. All age-eligible animals of those livestock species must be vaccinated according to label directions within the 12 months preceding entry to the event at the complex. For example, feeder/prospect class animals would be required to be vaccinated to be exhibited and return home. For animal species in which there is not a rabies vaccine product labeled for use (e.g., camelids, goats, swine), extra-label use of a vaccine is at the discretion of the exhibitor's veterinarian.

All rabies-vaccinated animals exhibited at the complex must be accompanied by a rabies vaccination certificate consistent with the National Association of State Public Health Veterinarians (NASPHV) guidelines, or the vaccination information must be included on the CVI or Veterinarian-client-patient-relationship (VCPR) form. The vaccine product administered, serial number, date of vaccination, and name of the veterinarian who performed the vaccination should be listed with the official ID of the animal(s) or the name(s) and written physical description(s) and on the CVI or VCPR.

- 2. Identification (ID):** There are ID requirements specific to the Pennsylvania Farm Show Complex. Cattle, swine, sheep, and goats must be identified with a 15 digit 840 ISO-compliant RFID ear tag. The only exception to this will be for cattle who were identified using a 900 series 15-digit ISO-compliant tag placed before January 1, 2015. No other exceptions will be granted. A person exhibiting at the complex shall distinguish between 840 tags with RFID capabilities versus 840 tags that do not have those capabilities prior to placing identification in an animal that is to be exhibited. Questions about ID should be addressed to the Department at 717-8841613.

The Great Stoneboro Fair

SUBCHAPTER C: ANIMAL HEALTH REQUIREMENTS AND RECOMMENDATIONS FOR ANIMAL EXHIBITION, INCLUDING COMMERCIAL EXHIBITION

TABLE OF CONTENTS

Section 1:	Pennsylvania Camelids
Section 2:	Out of State Camelids
Section 3:	Pennsylvania Cattle
Section 4:	Out of State Cattle
Section 5:	Pennsylvania Cervids
Section 6:	Out of State Cervids
Section 7:	Pennsylvania Dogs
Section 8:	Out of State Dogs
Section 9:	Pennsylvania Equine Animals
Section 10:	Out of State Equine Animals
Section 11:	Pennsylvania Goats
Section 12:	Out of State Goats
Section 13:	Pennsylvania Poultry, Unfertilized Eggs, and Ornamental Feathers
Section 14:	Out of State Poultry, Unfertilized Eggs, and Ornamental Feathers
Section 15:	Pennsylvania Rabbits
Section 16:	Out of State Rabbits
Section 17:	Pennsylvania Sheep
Section 18:	Out of State Sheep
Section 19:	Pennsylvania Swine
Section 20:	Out of State Swine
Subchapter D (annex):	Department Regulations References and Forms
	Biosecurity Guidelines for Show Managers
	Biosecurity Guidelines for Exhibitors
	Owner Endorsed Avian Health Certificate and Biosecurity Statement
	Veterinarian-Client-Patient-Relationship (VCPR) Form

The Great Stoneboro Fair

2024

PENNSYLVANIA DEPARTMENT OF AGRICULTURE

ANIMAL HEALTH REQUIREMENTS AND RECOMMENDATIONS FOR ANIMAL EXHIBITION, INCLUDING COMMERCIAL EXHIBITION

Section 1: Pennsylvania Camelids

I. Requirements:

The Department has no specific requirements for Pennsylvania camelids at fairs.

II. Recommendations:

1. A current Certificate of Veterinary Inspection (CVI) (valid for 30 days after the date of issue) OR a VCPR Form to verify animal ID.
2. All animals must be free of evidence of infectious and contagious diseases and a statement of this should be written on the CVI or VCPR Form.
3. Individual official identification (ID) include any of the following:
 - (a) A United States Department of Agriculture (USDA)-issued National Uniform Ear tagging System (NUES) tag .
 - (b) A 15-digit Animal Identification Number ear tag starting with "840". (c) An ISO-compliant 15-digit microchip.
4. For animals without any of the ID options listed in number 3 above, the animal's name and a description should be included on the CVI or VCPR Form. Description should include the animal's color, sex, breed, and any distinguishing markings. A photo may accompany the CVI or VCPR Form. **Section 2: Out of State Camelids I.**

Requirements:

1. A CVI issued within the 30 days prior to the date of importation.
2. Vesicular Stomatitis (VS): This applies to camelids entering Pennsylvania from states that experienced a Vesicular Stomatitis outbreak in the last 12 months. In these cases, an accredited veterinarian shall determine whether the animals are free from VS, and animals shall be accompanied by a CVI with the following statement signed by the accredited veterinarian: "All animals identified on this CVI have been examined and found to be free from VS. During the past 90 days, these animals have neither been exposed to VS nor

The Great Stoneboro Fair

located within 10 miles of a site where VS has been diagnosed.”

3. All animals must be free of evidence of infectious and contagious diseases and a statement of this is required on the CVI.
4. Individual official identification (ID) include any of the following:
 - (a) A United States Department of Agriculture (USDA)-issued National Uniform Ear tagging System (NUES) tag .
 - (b) A 15-digit Animal Identification Number ear tag starting with “840”. (c) An ISO-compliant 15-digit microchip.
5. Tuberculosis Testing Requirements:
 - (a) No test is required for animals originating from states or zones designated as accredited free by the USDA.
 - (b) All animals originating from states or zones designated modified accredited advanced by the USDA must be test negative within the 60 days prior to the date of importation. The negative test results and dates of tests must be included on the CVI or the animal must be accompanied by a negative test report (a copy of the original report is acceptable). (c) All animals originating from states or zones designated modified accredited by the USDA must originate from herds in which all animals 12 months of age and older are test negative within the 12 months prior to the date of importation and the individual animals (all ages) to be imported are also test negative within the 60 days prior to the date of importation and at least 60 days after the negative whole herd test was completed. The negative test results and date of test must be included on the CVI or the animal must be accompanied by a negative test report (a copy of the original test report is acceptable). (d) All camelids shall comply with the Department's “Interstate Order of Quarantine; Tuberculosis Testing Requirements for Importation of Cattle, Bison, Goats or Camelids” [49 Pa.B. 709, Saturday, February 16, 2019].

II. Recommendations:

All out of state camelids must meet all criteria listed above as “requirements”. The Department has no additional recommendations to prevent the introduction of contagious disease from out of state camelids.

The Great Stoneboro Fair

Section 3: Pennsylvania Cattle

I. Requirements:

1. Sexually intact cattle shall be identified by an official ear tag or other unique identification device approved by the Department. Official identification includes any of the following:
 - (a) A USDA issued National Uniform Eartagging System (NUES) tag
 - (b) A 15-digit Animal Identification Number (AIN) ear tag starting with "840"
 2. ID requirements specific to the Farm Show Complex:
 - (a) All cattle entering the complex must be identified with a 15 digit 840 ISO-compliant RFID ear tag.
 - (b) The only exception to this will be for cattle who were identified using a 900 series 15digit ISO-compliant tag placed before January 1, 2015. No other exceptions will be granted.
 - (c) A person exhibiting at the complex shall distinguish between 840 tags with RFID capabilities versus 840 tags that do not have those capabilities prior to placing identification in an animal that is to be exhibited.
2. See rabies vaccination requirements in the General section for animals exhibiting at the Pennsylvania Farm Show Complex.

II. Recommendations:

1. A current Certificate of Veterinary Inspection (CVI) (valid for 30 days after the date of issue). A current VCPR Form may also be used to verify animal ID.
In addition to the identification for sexually intact cattle, steers and spayed heifers should be identified with forms of ID consistent with # 1 in requirements above.
2. All animals must be free of evidence of infectious and contagious diseases and a statement of this should be written on the CVI.
3. A current rabies vaccination administered by a licensed veterinarian for animals 3 months of age and older (observe appropriate slaughter withdrawal time).
4. Rodeo: It is recommended that Pennsylvania-origin rodeo cattle of all ages be negative on an official tuberculin test within 60 days prior to the start of the fair unless they are members of and originate from an accredited tuberculosis-free herd. The cattle can be accompanied by the negative test report, or the tuberculosis test results can be recorded by the veterinarian on a CVI. **Section 4: Out of State Cattle I. Requirements:**

The Great Stoneboro Fair

1. A Certificate of Veterinary Inspection (CVI) issued within the 30 days prior to the date of importation.
 2. Vesicular Stomatitis (VS): This applies to cattle entering Pennsylvania from states that experienced a Vesicular Stomatitis outbreak in the last 12 months. In these cases, an accredited veterinarian shall determine whether the animals are free from VS, and animals shall be accompanied by a CVI with the following statement signed by the accredited veterinarian: "All animals identified on this CVI have been examined and found to be free from VS. During the past 90 days, these animals have neither been exposed to VS nor were located within 10 miles of a site where VS has been diagnosed."
 3. All animals must be free of evidence of infectious and contagious diseases and a statement of this is required on the CVI.
 4. Federal regulation (USDA) requires individual official animal identification for all cattle of any age for exhibition. Acceptable animal identification includes any of the following:
 - (a) A USDA issued National Uniform Eartagging System (NUES) tag
 - (b) A 15-digit Animal Identification Number (AIN) ear tag starting with "840"
 - (c) Brands registered with a recognized brand inspection authority and accompanied by an official brand inspection certificate, when agreed to by the shipping and receiving State or Tribal animal health authorities; or
 - (d) Tattoos and other identification methods acceptable to a breed association for registration purposes, accompanied by a breed registration certificate, when agreed to by the shipping and receiving State or Tribal animal health authorities.
 5. ID requirements specific to the Pennsylvania Farm Show Complex: All cattle entering the complex must be identified with a 15 digit 840 ISO-compliant RFID ear tag. The only exception to this will be for cattle who were identified using a 900 series 15-digit ISO-compliant tag placed before January 1, 2015. No other exceptions will be granted. A person exhibiting at the complex shall distinguish between 840 tags with RFID capabilities versus 840 tags that do not have those capabilities prior to placing identification in an animal that is to be exhibited.
 6. Tuberculosis testing requirements:
 - (a) No test is required for animals originating from states or zones designated as accredited free by the USDA.
 - (b) All animals originating from states or zones designated modified accredited advanced by the USDA must be test negative within the 60 days prior to the date of importation. The negative test results and dates of tests must be included on the CVI
-

The Great Stoneboro Fair

or the animal must be accompanied by a negative test report (a copy of the original report is acceptable).

- (c) All animals originating from states or zones designated modified accredited by the USDA must originate from herds in which all animals 12 months of age and older are test negative within the 12 months prior to the date of importation and the individual animals (all ages) to be imported are also test negative within the 60 days prior to the date of importation and at least 60 days after the negative whole herd test was completed. The negative test results and date of test must be included on the CVI or the animal must be accompanied by a negative test report (a copy of the original test report is acceptable).
- (d) All cattle shall comply with the Department's "Interstate Order of Quarantine; Tuberculosis Testing Requirements for Importation of Cattle, Bison, Goats or Camelids" [49 Pa.B. 709, Saturday, February 16, 2019].
- (e) **Special Tuberculosis Test requirement for Rodeo Cattle.** All rodeo cattle and bison from out of state shall be negative on an official tuberculosis test within 60 days prior to entering Pennsylvania unless they originate from and are members of an Accredited Tuberculosis-free herd within an accredited Tuberculosis-free state or zone. This requirement for rodeo cattle from out-of-state is in addition to all other requirements listed above for out-of-state cattle.

7. Rabies vaccination requirements: See rabies vaccination requirements in the General section for animals exhibiting at the Pennsylvania Farm Show Complex.

II. Recommendations:

1. While tattoos and brands are acceptable, NUES tags or 840 AIN tags are preferred
2. A current rabies vaccination administered by a licensed veterinarian is recommended for animals 3 months of age and older (observe appropriate slaughter withdrawal time).

The Great Stoneboro Fair

Section 5. Pennsylvania Cervids

Chronic Wasting Disease (CWD) program participants and temporary exhibition sites: Contact the Department (717-772-2852 or 717-787-4944) for specific requirements for exhibition of CWDsusceptible cervids to remain in compliance with CWD programs.

I. Requirements:

1. Individual official animal identification is required. Official ID includes any of the following:
 - (a) A legible and unique tattoo approved by the Department or USDA.
 - (b) A USDA-issued ear tag bearing a unique number provided by USDA that utilizes one of the following numbering systems:
 - (i) The National Uniform Ear tagging System (NUES).
 - (ii) The Animal Identification Number (AIN) ear tag bearing 15 digits starting with "840".
 - (iii) The premises-based numbering system using a Premises Identification Number (PIN) in conjunction with a livestock production numbering system.
 - (c) An electronic implant device, such as a microchip that utilizes a nationally unique 15digit animal identification number starting with "840" provided an appropriate reader is immediately available wherever the animal is located.

II. Recommendations:

1. A current Certificate of Veterinary Inspection (CVI) (valid for 30 days after the date of issue). A current VCPR Form may also be used to verify animal ID.
2. All animals must be free of evidence of infectious and contagious diseases and a statement of this should be written on the CVI.
3. Fair management is requested to provide contact information of owners of all cervids which are exhibited to Jody Boyer at the Department within 7 days of the last day of the exhibition (717-787-4944 or jboyer@pa.gov). **Section 6:**

Out of State Cervids I. Requirements:

1. All CWD-susceptible cervid species (including blacktail deer, elk, moose, mule deer, red deer, reindeer, sika deer, whitetail deer, and hybrids): A written importation permit is required from the Pennsylvania Department of Agriculture. Call Jody Boyer at 717-7874944 between 8 AM and 4 PM weekdays. Call for a permit at least 30 days in advance.
2. A Certificate of Veterinary Inspection (CVI) issued within the 30 days prior to the date of importation. The CVI shall confirm that the cervid originates from a herd that has been classified as "Certified" in a government administered CWD herd certification program with components as determined by 9 CFR Part 55.24.
3. Vesicular Stomatitis (VS): This applies to cervids entering Pennsylvania from states that experienced a Vesicular Stomatitis outbreak in the last 12 months. In these

The Great Stoneboro Fair

cases, an accredited veterinarian shall determine whether the animals are free from VS, and animals shall be accompanied by a CVI with the following statement signed by the accredited veterinarian: "All animals identified on this CVI have been examined and found to be free from VS. During the past 90 days, these animals have neither been exposed to VS nor located within 10 miles of a site where VS has been diagnosed."

4. All animals must be free of evidence of infectious and contagious diseases and a statement of this is required on the CVI.
5. Two forms of individual ID are required for CWD-susceptible species. One form of identification listed below is required as official animal identification. The second device may be either a second form of official animal identification or a form of individual animal identification which is unique to that animal within the herd, and which is linked to the CWD database. Non CWD-susceptible species require only the official form of identification; a second form is not required. Consultation with the Department on currently acceptable forms of identification is strongly recommended when anticipating importation of cervids. Official ID includes any of the following:

- (a) A legible and unique tattoo approved by the Department and USDA.
- (b) A USDA-issued ear tag, bearing a unique number provided by USDA that utilizes one of the following numbering systems:
 - (i) The National Uniform Eartagging System (NUES).
 - (ii) The Animal Identification Number (AIN) ear tag bearing 15 digits starting with "840".
 - (iii) The premises-based numbering system using a Premises Identification Number (PIN) in conjunction with a livestock production numbering system.
- (c) An electronic implant device, such as a microchip that utilizes a nationally unique 15digit animal identification number starting with "840" provided an appropriate reader is immediately available wherever the animal is located.

6. Brucellosis testing requirements:

- (a) All sexually intact cervids 12 months of age and older are test-eligible.
- (b) If the animal is from a brucellosis certified-free herd, no further testing is required.

The date of the most recent herd test and test results must be included on the CVI.

- (c) If the animal is from a brucellosis monitored herd, it must be brucellosis test negative within the 90 days prior to the date of importation. The date of the test and the test results must be included on the CVI or the animal must be accompanied by the laboratory test report (a copy of the test report is acceptable).
- (d) If the animal is from a herd with no brucellosis status, it must be brucellosis test negative within the 30 days prior to the date of importation. The date of the test and the test results must be included on the CVI or the animal must be accompanied by the laboratory test report (a copy of the test report is acceptable).

7. Tuberculosis testing requirements:

The Great Stoneboro Fair

- (a) Cervids of all ages are test-eligible.
- (b) If the animal is from a tuberculosis accredited herd, no further testing is required.
The date of the most recent herd test and test results must be included on the CVI.
- (c) If the animal is from a tuberculosis monitored or Qualified Herd, it must be tuberculosis test negative within the 90 days prior to the date of importation. The date of the test and test results must be included on the CVI or the animal must be accompanied by a negative test report (a copy of the original test report is acceptable). (d) If the animal is from a herd with no tuberculosis status, it must be test negative on two consecutive tuberculosis tests conducted at least 90 days apart, with the last test conducted within the 90 days prior to the date of importation. The date of the tests and test results must be included on the CVI or the animal must be accompanied by the negative test reports (copies of the test reports are acceptable).

II. Recommendations: Fair management is requested to provide contact information of owners of all cervids which are exhibited to Jody Boyer at the Department within 7 days of the last day of the exhibition (717-787-4944 or jboyer@pa.gov).

Section 7: Pennsylvania Dogs

- I. Requirements:** Proof of a current rabies vaccination is required for all exhibition dogs 12 weeks of age and older. All rabies-vaccinated dogs shall be accompanied by a rabies vaccination certificate consistent with the National Association of State Public Health Veterinarians (NASPHV) guidelines. A copy of the rabies vaccination certificate is acceptable.

II. Recommendations:

- 1. All animals are free of evidence of infectious and contagious diseases.
- 2. Identification, including a collar with a name plate bearing the name and address of the owner, and a microchip. **Section 8: Out of State Dogs I. Requirements:**

- 1. Proof of a current rabies vaccination is required for all exhibition dogs 12 weeks of age and older. All rabies-vaccinated dogs shall be accompanied by a rabies vaccination certificate consistent with the National Association of State Public Health Veterinarians (NASPHV) guidelines.
- 2. A Certificate of Veterinary Inspection (CVI) written within the 30 days prior to importation. Exemption: A person may bring one or more dogs into Pennsylvania for show or other demonstration without a CVI for a period not to exceed 30 days provided that each dog is equipped with a collar bearing a name plate giving the name and address of the owner.
- 3. **Not Acceptable:** The APHIS Form 7001, U.S. Interstate and International Certificate of Health Examination for Small Animals, is not accepted as a valid CVI.

II. Recommendations:

The Great Stoneboro Fair

1. All animals are free of evidence of infectious and contagious diseases.
2. Identification, including a collar with a name plate bearing the name and address of the owner, and a microchip.

Section 9:

Pennsylvania Equine

Animals I.

Requirements:

1. The Department of Agriculture has no specific requirements for Pennsylvania equines at fairs. However, fair management has the authority to impose requirements designed to prevent the spread of contagious diseases.
2. See rabies vaccination requirements in the General section for animals exhibiting at the Pennsylvania Farm Show Complex.

II. Recommendations:

1. A current Certificate of Veterinary Inspection (CVI) (valid for 30 days after the date of issue). A current VCPR Form may also be used to verify animal ID.
2. All animals must be free of evidence of infectious and contagious diseases and a statement of this should be written on the CVI.
3. It is recommended that all equine animals be test negative for Equine Infectious Anemia (EIA) by an official test within the 12 months prior to the opening date of the exhibition. Laboratory test results should accompany each animal to its final destination (a copy of the original lab report is acceptable). The CVI shall specify the date of sample collection and EIA test results. Foals less than six months of age accompanied by a test-negative dam are exempt from EIA testing recommendations. If the foal is not accompanied by the dam, a copy of the dam's test results must accompany the foal to its final destination.
4. A current rabies vaccination administered by a licensed veterinarian for animals 3 months of age and older. The name of the product used, date of administration and veterinarian administering the rabies vaccination should appear on the CVI or on a rabies vaccination certificate and this information should correlate to a written description of the horse, and any and all forms of identification associated with the horse, such as tattoos, brands, or microchips.
5. Permanent identification, including a microchip, tattoo, or brand. **Section 10: Out**

of State Equine Animals I. Requirements:

1. A Certificate of Veterinary Inspection (CVI) issued within the 30 days prior to the date of importation. **Please Note:** Extended Equine Certificates of Veterinary Inspection and Interstate Equine Event Permits will not be accepted. Brand Certificates will not be accepted as Certificates of Veterinary Inspection.

The Great Stoneboro Fair



2. Vesicular Stomatitis (VS) statement: This applies to horses entering Pennsylvania from states that experienced a Vesicular Stomatitis outbreak in the last 12 months. In these cases an accredited veterinarian shall determine whether the animals are free from VS, and animals shall be accompanied by a CVI with the following statement signed by the accredited veterinarian: "All animals identified on this CVI have been examined and found to be free from VS. During the past 90 days, these animals were not located within 10 miles of a site where VS has been diagnosed."
3. All animals must be free of evidence of infectious and contagious diseases and a statement of this is required on the CVI.
4. All equine animals must be test negative for Equine Infectious Anemia (EIA) by an official test within the 12 months prior to the date of importation. Laboratory test results must accompany each animal to its final destination (a copy of the original lab report is acceptable). The CVI shall specify the date of sample collection and EIA test results. Foals under six months of age accompanied by a dam with negative EIA official test results are exempt from EIA testing requirements. If the foal is not accompanied by the dam, a copy of the dam's test results must accompany the foal to its final destination.
5. If an equine animal has resided in Texas or New Mexico for a cumulative total of 30 days or more within the six months preceding the date of entry into the Commonwealth, that animal must be test-negative for *Babesia caballi* and *Theileria equi* on a competitive enzyme-linked immunosorbent assay (c-ELISA) test, or a Department-approved equivalent test, with the test occurring within the 30 days preceding entry into Pennsylvania. The date of test and the test results shall be written on the Certificate of Veterinary Inspection.
6. See rabies vaccination requirements in the General section for animals exhibiting at the Pennsylvania Farm Show Complex.

II. Recommendations:

1. A current rabies vaccination administered by a licensed veterinarian for animals 3 months of age and older. The name of the product used, date of administration and veterinarian administering the rabies vaccination should appear on the CVI or on a rabies vaccination certificate and this information should correlate to a written description of the horse, and any and all forms of identification associated with the horse- such as tattoos, brands, or microchips.
2. Permanent identification, including a microchip, tattoo, or brand.

The Great Stoneboro Fair

Section 11: Pennsylvania Goats I. Requirements:

1. Individual official animal identification is required for all goats. Identification used for goats must be permanently affixed to the individual animal. Official ID includes any of the following:
 - (a) A USDA ear tag with a US shield , which includes scrapie program tags (animals bearing identification with blue colored scrapie program tags labelled "meat" with a US shield  are not permitted to be exhibited in Pennsylvania. Please call the Department at 717-772-2852 if such a tag is encountered).
 - (b) A legible tattoo with herd and individual identification recognized in an approved USDA Scrapie database a.k.a. scrapie tattoo (flock ID in the right ear—state postal code and letters/numbers—and individual animal ID in the left ear).
 - (c) A breed registration tattoo if the animal is accompanied by a registration certificate and the tattoo is legible.

2. For post-exhibition sales the following requirements apply:
 - (a) Market goats must be documented on sales slips which contain all of the following information:
 - (i) Official identification (as described above)
 - (ii) Sale date
 - (iii) Sale location
 - (iv) Name, address and phone number of the exhibitor
 - (v) Hauler contact information
 - (vi) Destination name and contact information
 - (vii) Total number of animals in the shipment
 - (viii) Type of goat (i.e., meat, dairy, specific breed)
 - (ix) Signature of consignee, agent, or hauler
 - (b) Sales slips, or a document containing all of the information required under subsection (a) above, must follow the goats to their final destination (including slaughter facilities).
 - (c) Goats which are purchased with the intent of breeding and are traveling via interstate movement must have a valid Certificate of Veterinary Inspection (CVI) prior to movement to the destination state.
 - (d) A copy of the sale records slips as delineated above and a copy of any CVI, required under subsection (c) above, must be kept by the sale organizer for 5 years.

3. ID requirements specific to the Pennsylvania Farm Show Complex (Complex):
 - (a) Goats entering the complex must be identified with a 15 digit 840 ISO-compliant RFID ear tag. This can be in addition to the forms of ID listed above so long as only one 840 ID is used.
 - (b) A person exhibiting at the complex shall distinguish between 840 tags with RFID capabilities versus 840 tags that do not have those capabilities prior to placing identification in an animal that is to be exhibited.

The Great Stoneboro Fair



4. All goats shall comply with the Department's regulations regarding the intrastate transportation of goats found at 7 Pa.Code § 3.151).
5. All goats shall comply with the Department's "General Quarantine Order; Scrapie" [50 Pa.B. 4751, September 19, 2020].

II. Recommendations:

1. A current Certificate of Veterinary Inspection (CVI) (valid for 30 days after the date of issue). A current VCPR Form may also be used to verify animal ID.
2. All animals must be free of evidence of infectious and contagious diseases and a statement of this should be written on the CVI.

Section 12: Out of State Goats

I. Requirements:

1. A Certificate of Veterinary Inspection (CVI) issued within the 30 days prior to the date of importation into Pennsylvania.
2. Vesicular Stomatitis (VS) statement: This applies to states that experienced a VS outbreak in the last 12 months. In these cases, an accredited veterinarian shall determine whether the animals are free from VS, and animals shall be accompanied by a CVI with the following statement signed by the accredited veterinarian: "All animals identified on this CVI have been examined and found to be free from VS. During the past 90 days, these animals were not located within 10 miles of a site where VS has been diagnosed."
3. All animals must be free of evidence of infectious and contagious diseases and a statement of this is required on the CVI.
4. Individual official animal identification is required for all goats. Identification used for sheep and goats must be permanently affixed to the individual animal. Official ID includes any of the following:
 - (a) A USDA ear tag with a US shield ; which includes scrapie program tags (animals bearing identification with blue colored scrapie program tags labelled "meat" with a US shield  are not permitted to be exhibited in Pennsylvania. Please call the Department at 717-772-2852 if such a tag is encountered).
 - (b) A legible tattoo with herd and individual identification recognized in an approved USDA Scrapie database a.k.a. scrapie tattoo (flock ID in the right ear - state postal code and letters/numbers - and individual animal ID in the left ear).
 - (c) A breed registration tattoo if the animal is accompanied by a registration certificate and the tattoo is legible.
5. Tuberculosis testing requirements:

The Great Stoneboro Fair

- (a) No test is required for animals originating from states or zones designated as accredited-free by the USDA.
 - (b) All animals originating from states or zones designated modified accredited advanced by the USDA must be test negative within the 60 days prior to the date of importation. The negative test results and date of test must be included on the CVI or the animal must be accompanied by a negative test report (a copy of the original report is acceptable).
 - (c) All animals originating from states or zones designated modified accredited must originate from herds in which all animals 12 months of age and older have tested negative within the 12 months prior to the date of importation; and the individual animals (all ages) to be imported have also tested negative within the 60 days prior to the date of importation and at least 60 days after the negative whole herd test was completed. The negative test results and date of test must be included on the CVI or the animal must be accompanied by a negative test report (a copy of the original test report is acceptable).
 - (d) All goats shall comply with the Department's "Interstate Order of Quarantine; Tuberculosis Testing Requirements for Importation of Cattle, Bison, Goats or Camelids" [49 Pa.B. 709, Saturday, February 16, 2019].
6. For post-exhibition sales the following requirements apply:
- (a) Market goats must be documented on sales slips which contain all the following information:
 - (i) Official identification (as described above)
 - (ii) Sale date
 - (iii) Sale location
 - (iv) Name, address and phone number of the exhibitor
 - (v) Hauler contact information
 - (vi) Destination name and contact information
 - (vii) Total number of animals in the shipment
 - (viii) Type of goat (i.e., meat, dairy, specific breed)
 - (ix) Signature of consignee, agent, or hauler
 - (b) Sales slips, or a document containing all of the information required under subsection (a) above, must follow the goats to their final destination (including slaughter facilities).
 - (c) Goats which are purchased with the intent of breeding and are traveling via interstate movement must have a valid Certificate of Veterinary Inspection (CVI) prior to movement to the destination state.
 - (d) A copy of the sale records slips as delineated above and a copy of any CVI, required under subsection (c) above, must be kept by the sale organizer for 5 years.
7. ID requirements specific to the Pennsylvania Farm Show Complex (Complex):
- (a) Goats entering the complex must be identified with a 15 digit 840 ISO-compliant RFID ear tag. This can be in addition to the forms of ID listed above so long as only one 840 ID is used.
 - (b) A person exhibiting at the complex shall distinguish between 840 tags with RFID capabilities versus 840 tags that do not have those capabilities prior to placing identification in an animal that is to be exhibited.
-

The Great Stoneboro Fair

8. All goats shall comply with the Department's regulations regarding the importation of goats found at 7 Pa.Code §§ 3.21-3.23 and 3.25-3.28).
9. All goats shall comply with the Department's "Interstate/International Quarantine Order; Scrapie" [50 Pa.B. 4754, September 19, 2020].

II. Recommendations:

All out of state goats must meet all criteria listed above as "requirements". The Department has no additional recommendations to prevent the introduction of contagious disease from out of state goats.

Section 13: Pennsylvania Poultry, Unfertilized Eggs, and Ornamental

Feathers I. Definitions:

Poultry. The term includes all domesticated fowl, including chickens, turkeys, ostriches, emus, rheas, cassowaries, waterfowl, and game birds (pheasants, partridge, quail, grouse, and guineas); but excludes doves, pigeons, psittacine and passerine birds.

Poultry products. The term shall mean products of or made from poultry, including eggs, poultry parts or any goods or items containing poultry or made or derived from poultry, such as but not limited to, feathers including ornamental feathers and feathers used for arts and crafts, beaks, feet, down, or poultry parts.

II. Requirements:

1. Changes for exhibition of poultry and poultry products in 2024 if the Department has determined that there are currently no active HPAI control areas or surveillance zones in place in Pennsylvania, and at the Department's discretion:
 - (a) The 2024 *Animal Health Requirements and Recommendations for Animal Exhibition*, Including *Commercial Exhibition*, will reference the April 16, 2022 General Quarantine Order; Cancellation of Exhibition of Poultry and Their Hatching Eggs Due to Highly Pathogenic Avian Influenza or its successor Order, which may allow for limited exhibition of poultry and poultry products at venues that receive funding pursuant to the Pennsylvania Agricultural Fair Act referenced above, if the Department has determined that there are currently no active HPAI control areas or surveillance zones in place in Pennsylvania.
 - (b) If the Department has determined that there are currently no active HPAI control areas or surveillance zones in place in Pennsylvania, the exhibition of market poultry which will be moved directly to slaughter, unfertilized eggs, and ornamental feathers may be allowed, at the Department's discretion. The Department will provide notification to fair managers if any active HPAI control areas or surveillance zones are in place in Pennsylvania at the beginning of the 2024 fair season and will provide updates throughout the season as necessary. The placement of a HPAI control area or surveillance zone in Pennsylvania will result in the immediate reinstatement of the prohibition of exhibition for all poultry and all poultry products.

The Great Stoneboro Fair

2. No poultry exhibitions regardless of their funding, association, or venue may occur within a 10 km control area of a premises infected with Highly Pathogenic Avian Influenza (see Subchapter A. General Information Section, Paragraphs 2, 3, and 4). Poultry exhibitions may occur at venues or locations that are not within a current control area and do not receive funding pursuant to the Pennsylvania Agricultural Fair Act 3 P.S. § 1501 et seq. so long as the following requirements are met. Current Control area proximity may be checked at the Department's *Control Zone Address Checker* on the PADLS website by clicking on the following link: [Highly Pathogenic Avian Influenza \(arcgis.com\)](https://padeptag.maps.arcgis.com/apps/webappviewer/index.html?id=a9066a3d68a443a08043766cb84bf4ae) or by typing directly in the search bar: <https://padeptag.maps.arcgis.com/apps/webappviewer/index.html?id=a9066a3d68a443a08043766cb84bf4ae>.

3. **General Requirements for Poultry and Poultry Products:** Pennsylvania Poultry and Poultry Products shall meet all applicable regulations and requirements, including those set forth in Subchapter D. (relating to Pennsylvania Department of Agriculture Regulation and Quarantine Order Requirements), Section A (relating to animals for exhibition) and Section H. (relating to Poultry, Birds, Water and Game Fowl and their Hatching Eggs), and all testing and other requirements related to pullorum/typhoid.

4. **Requirements for Exhibition of Ornamental Feathers:**
 - (a) Shall be sourced in the United States.
 - (b) Ornamental feathers sourced from poultry to be entered into a competition or used to produce jewelry or other items to be exhibited or sold shall be free of visible manure, litter, or other debris.
 - (c) Transport container shall have been cleaned and disinfected before being used to transport feathers to the exhibition.
 - (d) An Owner Endorsed Avian Health Certificate and Biosecurity Statement or a Certificate of Veterinary Inspection (CVI) shall accompany the feathers. If a CVI is used, endorsement of biosecurity on the Owner Endorsed Avian Health Certificate and Biosecurity Statement shall also accompany the feathers.
 - (e) Ornamental feathers to be entered into a competition or used to produce jewelry or other items to be exhibited or sold shall originate from a flock which is not known to be infected with avian influenza. This requirement can be met by using one of the following methods:
 - (i) Ornamental feathers sourced from poultry shall originate from flock which has had a negative AI test (see testing requirements for poultry in Subsection 7 of this Section 13 below) within **14** days prior to the opening date of the exhibition.
 - (ii) The feathers shall be accompanied by the most recent test report (copy acceptable).
 - (iii) Ornamental feathers sourced from poultry to be entered into a competition or used to produce jewelry or other items to be exhibited or sold shall be clean and held in a clean area separate from poultry or other poultry products for at least 120 days at a minimum of 68 degrees Fahrenheit before exhibition. The date the feathers were moved to a holding area, along with the holding temperature, shall be included on the Owner Endorsed Avian Health Certificate and Biosecurity Statement or a Certificate of Veterinary Inspection (CVI). If a CVI is used, endorsement of biosecurity on the Owner Endorsed Avian Health Certificate and Biosecurity Statement shall also accompany the feathers.

5. **Requirements for Exhibition of Unfertilized Poultry Eggs:**

The Great Stoneboro Fair

- (a) Eggs shall be washed and sanitized in a 100-200 ppm chlorine solution or other disinfectant that is approved by the United States Environmental Protection Agency (EPA), which is effective in destroying influenza virus, and dried before being placed in a carton.
- (b) Eggs shall be packaged in a new cardboard or Styrofoam carton or in a plastic carton which was cleaned, disinfected, and dried, for entry into an event. (c) An Owner Endorsed Avian Health Certificate and Biosecurity Statement or a Certificate of Veterinary Inspection (CVI) shall accompany the eggs. If a CVI is used, endorsement of biosecurity on the Owner Endorsed Avian Health Certificate and Biosecurity Statement shall also accompany the eggs.
- (d) The eggs shall originate from a flock which had a negative AI test (see testing requirements for poultry in Subsection 7 of this Section 13 below) within **14** days prior to the opening date of the exhibition.
- (e) The eggs shall be accompanied by the most recent test report (copy acceptable).
- (f) If any eggs hatch at the exhibition, the hatchlings shall be removed immediately and returned to the farm of origin.

6. Requirements for Exhibition of Market Poultry:

- (a) All Pennsylvania poultry entering an exhibition must bear an official Department issued leg band. Ratites must be identified with a neck band or an electronic implant device (the exhibitor must supply a reader).
- (b) Poultry may be exhibited only if they will be moved immediately after judging directly from the fair/show grounds to a facility for slaughter. All poultry exhibited in Pennsylvania at Department sponsored or funded exhibitions shall move as all-in and all-out directly to a Department or USDA licensed slaughter facility following the animal exhibition and may not be diverted to premises other than a recognized slaughter establishment.
- (c) Arrival, exhibition, and departure of the poultry shall occur within a 72 hour window. The 72 hours begin when the first poultry arrive on the show grounds, whether unloaded or not, and ends when the last poultry physically leave the premises in a vehicle. (d) Waterfowl for exhibit shall be kept separate and apart from other poultry in a biosecure manner.
- (e) An Owner Endorsed Avian Health Certificate and Biosecurity Statement or a Certificate of Veterinary Inspection (CVI) shall accompany the poultry. If a CVI is used, endorsement of biosecurity on the Owner Endorsed Avian Health Certificate and Biosecurity Statement shall also accompany the poultry.
- (f) All poultry on the show grounds shall be monitored for signs of illness, and any signs of illness shall be reported to the Department immediately (717-772-2852).
- (g) All poultry on the show grounds shall be displayed behind barriers such as ropes to prevent public access to the poultry, with signage to prevent the public from crossing the barrier.
- (h) Conveyances shall be cleaned and disinfected before loading to transport poultry to the show, and after returning to the premises of origin.

7. Avian Influenza Testing and Verification:

- (a) All samples shall be collected by a Certified Poultry Technician or a Category II Accredited Veterinarian and shall be tested in a National Animal Health Laboratory Network (NAHLN) laboratory.

The Great Stoneboro Fair

- (b) All poultry for exhibition shall originate from a flock in which a random, representative sample of a minimum of 30 birds, 3 weeks of age or older, were tested for avian influenza within the **14** days prior to opening date of the exhibition.
- (c) For waterfowl, cloacal swab samples shall be collected for testing. Swabs from geese and ducks may not be combined in the same tube for testing.

- (d) For chickens, turkeys, game birds, and ratites, blood samples (AGID testing) or tracheal or oropharyngeal swab samples (PCR testing) are acceptable samples.

Samples from more than one species may not be combined in the same tube for testing.

- (e) The poultry shall be accompanied by the most recent test report (copy acceptable).

Test results shall be negative.

- (f) If there are fewer than 30 birds in the flock, test all birds of age.

- (g) Untested birds shall not be comingled with or added to the tested flock after negative samples have been collected and before the show.

- (h) Sample collectors and testers must maintain records of animal identification, testing records, and any other records required by the Domestic Animal Law and any order issued by the Department for a minimum of two years and must make records available to the Department upon request.

- (i) National Animal Health Laboratory Network (NAHLN) protocols for sample collection, including the number of swabs/tubes of viral transport media, and testing shall be followed. All samples must be tested at a NAHLN laboratory.

Section 14: Out of State Poultry, Unfertilized Eggs, and Ornamental Feathers

I. Definitions:

Poultry. The term includes all domesticated fowl, including chickens, turkeys, ostriches, emus, rheas, cassowaries, waterfowl, and game birds (pheasants, partridge, quail, grouse, and guineas); but excludes doves, pigeons, psittacine and passerine birds.

Poultry products. The term shall mean products of or made from poultry, including eggs, poultry parts or any goods or items containing poultry or made or derived from poultry, such as but not limited to, feathers including ornamental feathers and feathers used for arts and crafts, beaks, feet, down, or poultry parts.

II. Requirements:

1. Changes for poultry and poultry products in 2024 if the Department has determined that there are currently no active HPAI control areas or surveillance zones in place in Pennsylvania and at the Department's discretion:

- (a) The 2024 *Animal Health Requirements and Recommendations for Animal Exhibition*,

Including Commercial Exhibition, will reference the April 16, 2022 General Quarantine

Order; Cancellation of Exhibition of Poultry and Their Hatching Eggs Due to Highly Pathogenic Avian Influenza *or its successor Order*, which may allow for limited exhibition of poultry and poultry products at venues that receive funding pursuant to the

Pennsylvania Agricultural Fair Act referenced above, if the Department has

The Great Stoneboro Fair

determined that there are currently no active HPAI control areas or surveillance zones in place in Pennsylvania.

- (b) If the Department has determined that there are currently no active HPAI control areas or surveillance zones in place in Pennsylvania the exhibition of market poultry which will be moved directly to slaughter, unfertilized eggs, and ornamental feathers may be allowed, at the Department's discretion. The Department will provide notification to fair managers if any active HPAI control areas or surveillance zones are in place in Pennsylvania at the beginning of the 2024 fair season and will provide updates throughout the season as necessary. The placement of a HPAI control area or surveillance zone in Pennsylvania flock will reinstitute the prohibition for all poultry and poultry products in Pennsylvania.
2. Out of State Poultry, Unfertilized Eggs and Ornamental Feathers shall meet the standards established in and comply with all the requirements set forth in Section 13 (relating to Pennsylvania Poultry, Unfertilized Eggs and Ornamental Feathers) subsections 2. (relating to control area requirements), 4. (relating to requirements for exhibition of ornamental feathers), 5. (relating to requirements for exhibition of unfertilized poultry eggs), 6. (relating to requirements for exhibition of market poultry), and 7. (relating to avian influenza testing and verification).
 3. Out of State Poultry and Poultry Products shall meet all Federal and Pennsylvania import and interstate transportation regulations, including those set forth in Subchapter D. (relating to Pennsylvania Department of Agriculture Regulation and Quarantine Order Requirements), Section A. (relating to animals for exhibition and Section H. (relating to Poultry, Birds, Water and Game Fowl and their Hatching Eggs), and all testing and other requirements related to pullorum/typhoid. **Section 15: Pennsylvania Rabbits I. Requirements:**
 1. The Department of Agriculture has no specific requirements for Pennsylvania rabbits at fairs. However, fair management has the authority to impose requirements designed to prevent the spread of contagious diseases.
 2. The owner of the animal and the place of exhibition or destination shall meet the standards established at sections 2323 and 2327 of the Domestic Animal Law (3 Pa.C.S. §§ 2323 and 2327) and set forth in Subchapter A, paragraphs 9 and 10 of this document.
 3. The owner of the animal shall meet all general requirements for importation and intrastate movement as set forth in sections 3.3, 3.4, 3.5,3.6 and 3.7 of the Department's regulations (7 Pa.Code §§ 3.3-3.7).
 4. While on exhibit or at any time following exhibition, it is an obligation to report all mass mortality events and all rabbits who are ill and bleeding from eyes, nose, mouth, or have bloody stools to the Department's emergency line 717-772-2852, option 1. It is vital to quickly identify and prevent dangerous transmissible diseases such as Rabbit Hemorrhagic Disease (RHD) from spreading.

II. Recommendations:

The Great Stoneboro Fair

1. A current Certificate of Veterinary Inspection (CVI) (valid for 30 days after the date of issue). The CVI shall be written by an accredited veterinarian and shall contain the following statements:

“All Rabbits in the shipment have been examined for and found free of infectious, contagious or communicable diseases including RHD and there have not been multiple mortality events or rabbits exhibiting hemorrhages within the last 90 days. The rabbits in this shipment have not been housed or exhibited with any rabbits associated with known mass mortality or hemorrhage events.”

“In the last 90 days, the rabbits in this shipment, have not been exhibited in, housed in, or traveled to, any state or territory in which RHD has been diagnosed within the last 12 months. In addition, during the last 90 days, they have had no contact with any captive or wild rabbit which originated from or travelled to one of those affected states or territories.”

2. Vaccination against RHDV-2: Vaccination of Pennsylvania origin rabbits against RHDV-2 is encouraged.

Section 16: Out of State Rabbits

I. Requirements:

1. Interstate and International Order of Quarantine: The owner and the exhibition or destination shall comply with the requirements of the Department's quarantine order, "Interstate/International Quarantine Order; Rabbit Hemorrhagic Disease [50 Pa.B. 5272, Saturday, September 26, 2020].
2. **Rabbits originating from a Commonwealth, State, Territory or Country identified as being affected by RHD within the 12 months prior to the start of the exhibition:** No rabbits or their products, such as meat, pelts, hides, carcasses or other items, and no equipment, exposed feed, forages, or conveyances or other items or associated materials may enter the Commonwealth of Pennsylvania from a Commonwealth, State, Territory, or Country where RHD has been diagnosed in the prior twelve (12) months or there is a reasonable suspicion it exists unless they meet the following requirements:
 - (a) All live rabbits must be accompanied by a CVI and must be examined by an accredited veterinarian **within the seventy-two (72) hours** prior to the date of shipment to the Commonwealth of Pennsylvania. The CVI must include statements by an accredited veterinarian certifying that:
 - (i) All rabbits in the shipment have been examined for and found free of infectious, contagious or communicable diseases;
 - (ii) All rabbits have originated from a single premises that has no signs of infectious, contagious or communicable disease in rabbits;
 - (iii) There have been no movements of rabbits onto the premises of origin within the 90 days prior to the date of shipment; and
 - (iv) The rabbits have had no contact with wild or captive rabbits other than their cohorts in the 90 days prior to the date of shipment.
 - (b) No rabbits or their products, such as meat, pelts, hides, carcasses or other items, and no equipment, exposed feed or conveyances or other items or associated materials may enter the Commonwealth of Pennsylvania from a premises exposed to, contaminated with or known to be affected with RHD, or

The Great Stoneboro Fair



where there is a reasonable suspicion the disease exists or the rabbits have been exposed to or infected with RHD.

II. Recommendations:

1. **For all rabbits:** Vaccination against RHDV-2 is encouraged. PLEASE NOTE: Vaccination of rabbits does not exempt the rabbit, rabbit products, or equipment used for them, from meeting the import requirements set forth in the Department's "Interstate/International Quarantine Order; Rabbit Hemorrhagic Disease [50 Pa.B. 5272, Saturday, September 26, 2020] and listed in subsections I. 1. and 2. (relating to requirements) above.
2. **For rabbits that originate from a Commonwealth, State, Territory, or Country where RHD has NOT been diagnosed in the prior twelve (12) months or there is NO reasonable suspicion it exists:** A Certificate of Veterinary Inspection (CVI) (valid for 30 days after the date of issue) shall be issued and shall include statements by an accredited veterinarian certifying that:

"All rabbits in the shipment have been examined for and found free of infectious, contagious or communicable diseases including RHD and there have not been multiple mortality events or rabbits exhibiting hemorrhages within the last 90 days. The rabbits in this shipment have not been housed or exhibited with any rabbits associated with known mass mortality or hemorrhage events."

"In the last 90 days, the rabbits in this shipment, have not been exhibited in, housed in, or traveled to, any state or territory in which RHD has been diagnosed within the last 12 months. In addition, during the last 90 days, they have had no contact with any captive or wild rabbit originating from or travelled to one of those affected states or territories." **Section 17: Pennsylvania Sheep I. Requirements:**

1. Individual official animal identification is required for all sheep. Identification used for sheep must be permanently affixed to the individual animal. Official ID includes any of the following:
 - (a) A USDA ear tag with a US shield ; which includes scrapie program tags (animals bearing identification with blue colored scrapie program tags labelled "meat" with a US shield  are not permitted to be exhibited in Pennsylvania. Please call the Department at 717-772-2852 if such a tag is encountered).
 - (b) A legible tattoo with herd and individual identification recognized in an approved USDA Scrapie database a.k.a. scrapie tattoo (flock ID in the right ear—state postal code and letters/numbers—and individual animal ID in the left ear).
 - (c) A breed registration tattoo if the animal is accompanied by a registration certificate and the tattoo is legible.
 2. For post-exhibition sales the following requirements apply:
 - (a) Market sheep must be documented on sales slips which contain all of the following information:
 - (i) Official identification (as described above)
 - (ii) Sale date
 - (iii) Sale location
 - (iv) Name, address and phone number of the exhibitor
-

The Great Stoneboro Fair

- (v) Hauler contact information
 - (vi) Destination name and contact information
 - (vii) Total number of animals in the shipment
 - (viii) Type of sheep (i.e., meat, dairy, specific breed)
 - (ix) Signature of consignee, agent, or hauler
- (b) Sales slips, or a document containing all of the information required under subsection (a) above, must follow the sheep to their final destination (including slaughter facilities).
 - (c) Sheep which are purchased with the intent of breeding and are traveling via interstate movement must have a valid Certificate of Veterinary Inspection (CVI) prior to movement to the destination state.
 - (d) A copy of the sale records slips as delineated above and a copy of any CVI, required under subsection (c) above, must be kept by the sale organizer for 5 years.
- 3. ID requirements specific to the Pennsylvania Farm Show Complex (Complex):
 - (a) Sheep entering the complex must be identified with a 15 digit 840 ISO-compliant RFID ear tag. This can be in addition to the forms of ID listed above so long as only one 840 ID is used.
 - (b) A person exhibiting at the complex shall distinguish between 840 tags with RFID capabilities versus 840 tags that do not have those capabilities prior to placing identification in an animal that is to be exhibited.
 - 4. See rabies vaccination requirements for exhibition of sheep at the Pennsylvania Farm Show Complex in the general section.
 - 5. All sheep shall comply with the Department's regulations regarding the intrastate transportation of sheep found at 7 Pa.Code §§ 3.161-3.163).
 - 6. All sheep shall comply with the Department's "General Quarantine Order; Scrapie" [50 Pa.B. 4751, September 19, 2020].



II. Recommendations:

- 1. A current Certificate of Veterinary Inspection (CVI) (valid for 30 days after the date of issue). A current VCPR Form may also be used to verify animal ID.
- 2. All animals must be free of evidence of infectious and contagious diseases and a statement of this should be written on the CVI.
- 3. A current rabies vaccination administered by a licensed veterinarian for animals 3 months of age and older (observe appropriate slaughter withdrawal time). **Section**

18: Out of State Sheep I. Requirements:

- 1. A Certificate of Veterinary Inspection (CVI) issued within the 30 days prior to entry into Pennsylvania.

The Great Stoneboro Fair

2. Vesicular Stomatitis (VS) Statement: This applies to states that experienced a VS outbreak in the last 12 months. In these cases, an accredited veterinarian shall determine whether the animals are free from VS, and animals shall be accompanied by a CVI with the following statement signed by the accredited veterinarian: "All animals identified on this CVI have been examined and found to be free from VS. During the past 90 days, these animals were not located within 10 miles of a site where VS has been diagnosed."
3. All animals must be free of evidence of infectious and contagious diseases and a statement of this is required on the CVI.
4. Individual official USDA scrapie animal identification is required. Identification used for sheep must be permanently affixed to the individual animal. Official scrapie ID includes any of the following:
 - (a) A USDA ear tag with a US shield ; which includes scrapie program tags (animals bearing identification with blue colored scrapie program tags labelled "meat" with a US shield  are not permitted to be exhibited in Pennsylvania. Please call the Department at 717-772-2852 if such a tag is encountered).
 - (b) A legible tattoo with herd and individual identification recognized in an approved USDA Scrapie database a.k.a. scrapie tattoo (flock ID in the right ear - state postal code and letters/numbers - and individual animal ID in the left ear).
 - (c) A breed registration tattoo if the animal is accompanied by a registration certificate and the tattoo is legible.
5. ID requirements specific to the Pennsylvania Farm Show Complex (Complex):
 - (a) Sheep entering the complex must be identified with a 15 digit 840 ISO-compliant RFID ear tag. This can be in addition to the forms of ID listed above so long as only one 840 ID is used.
 - (b) A person exhibiting at the complex shall distinguish between 840 tags with RFID capabilities versus 840 tags that do not have those capabilities prior to placing identification in an animal that is to be exhibited.
6. For post-exhibition sales the following requirements apply:
 - (a) Market sheep must be documented on sales slips which contain all the following information:
 - (i) Official identification (as described above)
 - (ii) Sale date
 - (iii) Sale location
 - (iv) Name, address and phone number of the exhibitor
 - (v) Hauler contact information
 - (vi) Destination name and contact information
 - (vii) Total number of animals in the shipment
 - (viii) Type of sheep (i.e., meat, dairy, specific breed)
 - (ix) Signature of consignee, agent, or hauler

The Great Stoneboro Fair

- (b) Sales slips, or a document containing all of the information required under subsection (a) above, must follow the sheep to their final destination (including slaughter facilities).
 - (c) Sheep which are purchased with the intent of breeding and are traveling via interstate movement must have a valid Certificate of Veterinary Inspection (CVI) prior to movement to the destination state.
 - (d) A copy of the sale records slips as delineated above and a copy of any CVI, required under subsection (c) above, must be kept by the sale organizer for 5 years.
- 7. See rabies vaccination requirements for exhibition of sheep at the Farm Show Complex in the general section.
 - 8. All sheep shall comply with the Department's regulations regarding the importation of sheep found at 7 Pa.Code §§ 3.121-3.123.
 - 9. All sheep shall comply with the Department's "Interstate/International Quarantine Order; Scrapie" [50 Pa.B. 4754, September 19, 2020].

II. Recommendations:

A current rabies vaccination administered by a licensed veterinarian for animals 3 months of age and older (observe appropriate slaughter withdrawal time).

Section 19: Pennsylvania Swine

Requirements:

- 1. No swine species shall be exhibited in Pennsylvania unless each animal is in compliance with all of the following:
 - (a) Is accompanied by a Certificate of Veterinary Inspection (CVI) issued within the 30 days prior to the date of the exhibition.
 - (b) Is permanently identified by an official 840 series RFID ear tag and the ear tag number is recorded on the CVI.
 - (c) Has been visually inspected and found to be free of signs of contagious disease immediately prior to unloading at the exhibition by an accredited veterinarian or swine health monitor appointed by the fair board or livestock show committee.
 - (d) Is inspected by a certified swine health monitor appointed by the fair or show/event organizers.
 - (i) Swine health monitors must undergo annual online training which can be found at the following link: [Pennsylvania Show and Fair Swine Health Monitor Training \(psu.edu\)](https://www.psu.edu/extension/pennsylvania-show-and-fair-swinehealth-monitor-training) or the following site [Extension.psu.edu/Pennsylvania-show-and-fair-swinehealth-monitor-training](https://www.extension.psu.edu/Pennsylvania-show-and-fair-swinehealth-monitor-training).
 - (ii) Swine health monitors must provide a current completion certificate to the fair or show staff they will be performing monitoring services for, prior to the start of the event.
- 2. All breeding swine exhibitions must occur prior to the arrival of any market swine. All the following conditions apply:
 - (a) Castrated swine shall not be classified as breeding swine.

The Great Stoneboro Fair

- (b) Breeding swine shall be removed from the animal exhibition premises prior to any market swine arriving.
 - (c) Breeding swine for exhibitions shall arrive, exhibit, and depart in a period no greater than 72 hours. Time begins when the first swine arrives physically on the fairgrounds whether unloaded from a trailer or not and ends when the last hog physically leaves the premises on a trailer.
 - (d) Swine birthing exhibitions and educational displays in which swine are not competing may occur concurrently with market swine animal exhibition, as long as reasonable precaution is made to ensure the biosecurity of the swine birthing exhibition or educational display. Consult your Department regional veterinarian or your herd veterinarian for biosecurity advice.
3. All market swine exhibited in Department sponsored or funded market shows shall move as all-in and all-out directly to a Department or USDA licensed slaughter facility following the animal exhibition and may not be diverted to premises other than a recognized slaughter establishment or a slaughter market in which the sales are designated slaughter-only sales.
4. Shows that are not sponsored by or that do not receive funding from the Department, including jackpot shows and 4-H roundups, not occurring during a Department sponsored or funded fair or show are exempt from the terminal slaughter requirement only if the following conditions are adhered to:
- (a) As is stated above, the swine shall be accompanied by a Certificate of Veterinary Inspection issued within the 30 days prior to the date of the exhibition and shall be permanently identified by an 840 series RFID identification ear tag.
 - (b) Arrival, exhibition and departure of the swine shall occur within a 72-hour window. Time begins when the first swine arrives physically on the exhibition grounds, whether unloaded from a trailer or not, and ends when the last hog physically leaves the premises on a trailer.
 - (c) There shall be no public access to the animals other than observation during competitions.
 - (d) An accredited veterinarian or trained swine health monitor shall have visually inspected the animals prior to unloading and found each animal to be free of signs of contagious disease.
 - (e) An accredited veterinarian or trained swine health monitor shall monitor and record the health of the pigs daily for signs of contagious disease, and the accredited veterinarian shall immediately report suspicion of disease to the State Animal Health Official.
 - (f) A Veterinary-client-patient-relationship is established between the show committee/management staff and an accredited veterinarian, and that veterinarian is readily available for health monitoring, emergency coverage, treatment, follow up evaluation, and prompt reporting of suspicion of disease to the State Animal Health Official.
5. The swine shall be in compliance with the Department's regulations regarding health requirements and intrastate transportation of swine found a 7 Pa.Code §§ 3.172-3.180.
6. The swine shall comply with the Department's general quarantine orders; "General Quarantine Order; Swine Exhibition Requirements" [51 Pa.B. 3861, Saturday, July
-

The Great Stoneboro Fair

17, 2021], "Addendum to the General Quarantine Order; Swine Exhibition Requirements" [52 Pa.B. 2362, April 23, 2022] and "Interstate/International and General Quarantine Order; Importation and Intrastate Movement of Swine" [39 Pa.B. 5442, September 19, 2009].

Section 20: Out of State Swine

Requirements:

1. A Certificate of Veterinary Inspection (CVI) issued within the 30 days prior to the date of the exhibition is required. The CVI shall include a statement verifying that the swine have not been fed raw garbage.
2. Vesicular Stomatitis (VS) Statement: This applies to states that experienced a VS outbreak in the last 12 months. In these cases, an accredited veterinarian shall determine whether the animals are free from VS, and animals shall be accompanied by a CVI with the following statement signed by the accredited veterinarian: "All animals identified on this CVI have been examined and found to be free from VS. During the past 90 days, these animals were not located within 10 miles of a site where VS has been diagnosed."
3. All animals must be free of evidence of infectious and contagious diseases and a statement of this is required on the CVI.
4. The swine shall comply with all the provisions of subsections 1. through 4. of Section 19 (relating to Pennsylvania Swine Requirements) above.
5. Individual animal ID – must be permanently identified by an official 840 series RFID ear tag and the ear tag number is recorded on the CVI.
6. Brucellosis Testing Requirements: No Brucellosis test is required if the animal originates from a validated brucellosis-free herd within a Brucellosis free state. All others must be tested negative within the 30 days prior to the date of importation. The date of test and test results must be included on the CVI.
7. Pseudorabies Testing Requirements: No Pseudorabies test is required if the animal originates from a Qualified Pseudorabies-free herd within a Pseudorabies free state. All others must be tested negative within the 30 days prior to the date of importation. The date of test and test results must be included on the CVI.
8. All breeding swine exhibitions must occur prior to the arrival of any market swine. All the following conditions apply:
 - (a) Castrated swine shall not be classified as breeding swine.
 - (b) Breeding swine shall be removed from the animal exhibition premises prior to any market swine arriving.
 - (c) Breeding swine for exhibitions shall arrive, exhibit, and depart in a period no greater than 72 hours. Time begins when the first swine arrives physically on the fairgrounds whether unloaded from a trailer or not and ends when the last hog physically leaves the premises on a trailer.

The Great Stoneboro Fair

- (d) Swine birthing exhibitions and educational displays in which swine are not competing may occur concurrently with market swine animal exhibition, as long as reasonable precaution is made to ensure the biosecurity of the swine birthing exhibition or educational display. Consult your Department regional veterinarian or your herd veterinarian for biosecurity advice.
9. All market swine exhibited in Department sponsored or funded market shows shall move on an all-in all-out basis directly to a Department or USDA licensed slaughter facility following the animal exhibition and may not be diverted to premises other than a recognized slaughter establishment or a slaughter market in which the sales are designated slaughter-only sales.
10. Shows that are not sponsored by or that do not receive funding from the Department, including jackpot shows and 4-H roundups, not occurring during a Department sponsored or funded fair or show are exempt from the terminal slaughter requirement only if the following conditions are adhered to:
- (a) As is stated above, the swine shall be accompanied by a Certificate of Veterinary Inspection issued within the 30 days prior to the date of the exhibition and shall be permanently identified by an 840 series RFID identification ear tag.
- (b) Arrival, exhibition and departure of the swine shall occur within a 72-hour window. Time begins when the first swine arrives physically on the exhibition grounds, whether unloaded from a trailer or not, and ends when the last hog physically leaves the premises on a trailer.
- (c) There shall be no public access to the animals other than observation during competitions.
- (d) An accredited veterinarian or trained swine health monitor shall have visually inspected the animals prior to unloading and found each animal to be free of signs of contagious disease.
- (e) An accredited veterinarian or trained swine health monitor shall monitor and record the health of the pigs daily for signs of contagious disease, and the accredited veterinarian shall immediately report suspicion of disease to the State Animal Health Official.
- (f) A Veterinary-client-patient-relationship is established between the show committee/management staff and an accredited veterinarian, and that veterinarian is readily available for health monitoring, emergency coverage, treatment, follow up evaluation, and prompt reporting of suspicion of disease to the State Animal Health Official.
11. The swine shall comply with the Department's regulations regarding interstate transportation and importation of swine found a 7 Pa.Code §§ 3.131-3.139.
12. The swine shall comply with the Department's interstate and international quarantine orders; "Interstate and International Quarantine Order; Swine Exhibition Requirements" [51 Pa.B. 3864, Saturday, July 17, 2021], "Addendum to the Interstate and International Quarantine Order; Swine Exhibition Requirements" [52 Pa.B. 2363, April 23, 2022] and "Interstate/International and General Quarantine Order; Importation and Intrastate Movement of Swine" [39 Pa.B. 5442, September 19, 2009].

SUBCHAPTER D. (Annex)

The Great Stoneboro Fair

Requirements

- A. **Animals for exhibition** in Pennsylvania must meet specific requirements under each species, as well as the General Provisions in the Department's regulations established at Title 7 of the Pennsylvania Code, and listed below:
1. Importation of domestic animals - Section 3.3 of the regulations (7 Pa.Code § 3.3).
 2. Health Certificate requirements of imported animals- Section 3.4 of the regulations (7 Pa.Code § 3.4).
 3. Health Certificate requirements for Pennsylvania animals - Section 3.7 of the regulations (7 Pa.Code § 3.7).
- B. **Camelids** for exhibition in Pennsylvania must meet the requirements of the Department's regulations established at Title 7 of the Pennsylvania Code, and listed below:
1. Specific provisions for interstate transport of camelids – Section 3a.3 of the regulations (7 Pa.Code § 3a.3).
 2. Camelids must also meet the regulations as set forth in the Department's quarantine order: Tuberculosis Testing Requirements for Importation of Cattle, Bison, Goats or Camelids [49 PaB. 709, February 16, 2019].
 3. Interstate/International Quarantine Order; Vesicular Stomatitis [36 Pa.B. 7974, December 30, 2006].
- C. **Cattle** for exhibition in Pennsylvania must meet the requirements of the Department's Quarantine Orders, regulations as set forth in Title 7 of the Pennsylvania Code and Section 9 of the Federal Code of Regulations, 9 CFR, listed below:
1. Section 3.151 of Title 7 of the Pennsylvania Code establishes specific provisions for intrastate transport of cattle, goats, and buffalo (7 Pa.Code § 3.151).
 2. Sections 3.21- 3.28 (relating to general provisions; brucellosis requirements; tuberculosis requirements; exhibition requirements for cattle and buffalo; import requirements for goats; cattle, goats, and buffalo for immediate slaughter; disease-free cattle, goats and buffalo and cattle, goats and buffalo from infected herds) of Title 7 of the Pennsylvania Code establish specific provisions for interstate transport of cattle, goats, and buffalo (7 Pa.Code §§ 3.21-3.28).
 3. Cattle must also meet the requirements set forth in the Department's quarantine orders and Federal Code of Regulations set forth below:
 - (a) Interstate Order of Quarantine; Tuberculosis Testing Requirements for Importation of Cattle, Bison, Goats and Camelids [49 Pa.B. 709, February 16, 2019].
 - (b) Interstate/International Quarantine Order; Vesicular Stomatitis [36 Pa.B. 7974, December 30, 2006].
 - (c) 9 CFR 86.4 (relating to Official identification).

The Great Stoneboro Fair

- D. **Cervids** for exhibition in Pennsylvania must meet the requirements of the Department's Quarantine Orders and of the Department's regulations established at Title 7 of the Pennsylvania Code, and listed below:
1. Section 3a.3 of Title 7 of the Pennsylvania Code establishes specific provisions for importation of cervids (7 Pa.Code § 3a.3).
 2. Section 3a.4 of Title 7 of the Pennsylvania Code establishes specific provisions for intrastate transport, including identification and health requirements (exhibition and comingling) of cervids (7 Pa.Code § 3a.4).
 3. **Commonwealth origin cervids** must also meet the requirements for movement and exhibition set forth in the Department's General Quarantine Order; Chronic Wasting Disease Program Requirements for Herd Certification Program and Herd Monitoring Program [44 Pa.B. 2249, Saturday, April 12, 2014], including only movement of cervids from fully "certified herds" and not movement of such cervids back onto a "certified herd" location after display or exhibition. There shall be no movement of cervids from a location within the Core Captive Management Zone, as established by General Quarantine Order; Cervid Movement Restrictions Within Core Captive Management Zone [50 Pa.B. 4395, Saturday, August 29, 2020].
 4. **Imported cervids** for exhibition in Pennsylvania must also meet the requirements set forth in the Interstate/International Quarantine Order; Chronic Wasting Disease Importation Requirements for Farmed or Captive Chronic Wasting Disease-Susceptible Cervids [50 Pa.B. 4650, Saturday, September 12, 2020].
 5. Only cervids originating from a Chronic Wasting Disease Certified Herd in a State with an approved Certified Herd Program may be shipped interstate.
 6. Interstate/International Quarantine Order; Vesicular Stomatitis [36 Pa. B. 7974, December 30, 2006].
- E. **Dogs** for exhibition in Pennsylvania must meet requirements of the Department's Statutes, Quarantine Orders, and the Department's regulations established at Title 7 of the Pennsylvania Code, and listed below:
1. Rabies Prevention and Control in Domestic Animals and Wildlife Act – 3 P.S. §455.8 (related to vaccination required; certificate and tag) and the attending regulations (7 Pa.Code §§ 16.41-16.46).
 2. General Quarantine Order [48 Pa.B. 6390, Saturday, October 6, 2018].
 3. Section 3.91 establishes specific provisions for interstate transport, including identification and health requirements (related to interstate health certificate required) of Title 7 of the Pennsylvania Code (7 Pa.Code § 3.91).
 4. Section 3.92 establishes specific provisions for dogs temporarily within the Commonwealth (related to show dog exempt for 30 days) (7 Pa.Code § 3.92).
- F. **Equines** for exhibition in Pennsylvania must meet the requirements of the Department's Quarantine Orders and of the Department's regulations established at Title 7 of the Pennsylvania Code, and listed below:
-

The Great Stoneboro Fair

1. Sections 3.211 (related to diseased equidae; permit required) 3.215 (related to fairs, shows and sales) and 3.221 (related to equine infectious anemia) establish specific provisions for intrastate transport of equine animals (7 Pa.Code §§ 3.211 and 3.221).
2. Sections 3.101 (related to interstate health certificate required), 3.103 (related to test methods), and 3.105 (related to equidae imported from quarantined areas; permit required) establish specific provisions for interstate transport of equine animals (7 Pa.Code §§ 3.101, 3.103 and 3.105).
3. Equines for importation must also meet the requirements set forth in: Interstate Quarantine Order; Equine Piroplasmiasis [40 Pa.B. 3966, Saturday, July 17, 2010].
4. Interstate/International Quarantine Order; Vesicular Stomatitis [36 Pa.B. 7974, December 30, 2006].

G. Goats for exhibition in Pennsylvania must meet the requirements of the Department's Quarantine Orders, regulations as set forth in Title 7 of the Pennsylvania Code and Section 9 of the Federal Code of Regulations, 9 CFR, listed below:

1. Section 3.151 (relating to general provisions) establishes specific provisions for intrastate transport of cattle, goats, and buffalo (7 Pa.Code § 3.151).
2. Sections 3.21 – 3.28 (relating to general provisions; brucellosis requirements; tuberculosis requirements; exhibition requirements for cattle and buffalo; import requirements for goats; cattle, goats, and buffalo for immediate slaughter; disease-free cattle, goats and buffalo and cattle, goats and buffalo from infected herds) of Title 7 of the Pennsylvania Code establish specific provisions for interstate transport of cattle, goats, and buffalo (7 Pa.Code §§ 3.21-3.28).
3. Goats must also meet the requirements set forth in the Department's quarantine orders regarding Scrapie at, General Quarantine Order; Scrapie [50 Pa.B. 4751, September 19, 2020] and Interstate/International Quarantine Order; Scrapie [50 Pa.B. 4754, September 19, 2020].
4. Goats must also meet the requirements set forth in the Department's quarantine order regarding tuberculosis, "Interstate Order of Quarantine; Tuberculosis Testing Requirements for Importation of Cattle, Bison, Goats or Camelids" [49 Pa.B. 709, February 16, 2019].
5. Goats for exhibition must meet the individual and group identification, flock origin, comingling, transportation, transfer, sale, and recordkeeping requirements established in the Code of Federal Regulations at 9 CFR 79.2 (relating to identification and records requirements for sheep and goats in interstate commerce).

H. Poultry, Birds, Water and Game Fowl and their Hatching Eggs for exhibition in Pennsylvania must meet the requirements of the Department's Quarantine Orders and of the Department's regulations established at Title 7 of the Pennsylvania Code, and listed below:

1. Sections 3.191 - 3.198 (relating to shipping containers, immediate slaughter, health, records, reports and inspections, officials' report and

The Great Stoneboro Fair

health certificates for shows, exhibitions or displays, condemnation, quarantine) establish specific provisions for intrastate transportation for all types of Poultry, Birds, Water and Game Fowl and Their Hatching Eggs (7 Pa.Code §§ 3.191-3.198).

2. Sections 3.111 - 3.119 (relating to shipping containers, immediate slaughter, health requirements, records and reports, temporary imports for shows, exhibitions and displays: health certificate, commercial, backyard or exhibition types of poultry, water and game fowl and their hatching eggs, pet or wild types of birds and their hatching eggs, refusal or condemnation of imports, quarantine) establish specific provisions for importation and interstate transport of all types of Poultry, Birds, Water and Game Fowl and Their Hatching Eggs (7 Pa.Code §§ 3.111 - 3.119).
3. The "General Quarantine Order; Virus Control for Highly Pathogenic Avian Influenza Poultry, Poultry Litter, Conveyances, Feed, Refuse, Containers, and Material Standards" [52 Pa.B. 2597, April 30, 2022].
4. The "General Quarantine Order; Cancellation of Exhibitions of Poultry and Their Hatching Eggs Due to Highly Pathogenic Avian Influenza" [52 Pa B. 2223, April 16, 2022].
5. The "Interstate/International Quarantine Order; Avian Influenza" [49 Pa.B. 3630, Saturday, July 13, 2019].
6. The "General Quarantine Order; Poultry Exhibition Requirements" [49 Pa.B. 3093, June 15, 2019].
7. The "Interstate Quarantine Order; Importation Requirements for Virus Control for Virulent or Exotic Newcastle Disease" [49 Pa.B. 936, Saturday, March 2, 2019].
8. The "Interstate/International and General Quarantine Order; Virus Control for Highly Pathogenic Avian Influenza Poultry at Competitions, Shows, Fairs and Exhibitions" [47 Pa.B. 1857, Saturday, April 1, 2017].
9. The "Interstate and General Quarantine Order; Virus Control for Highly Pathogenic Avian Influenza Vehicle, Container and Material Standards" [45 Pa.B 4930, August 22, 2015].

I. **Rabbits** for exhibition in Pennsylvania must meet the requirements of the Department's Quarantine Order listed below:

1. The "Interstate/International Quarantine Order; Rabbit Hemorrhagic Disease [50 Pa.B. 5272, September 26, 2020].

J. **Sheep** for exhibition in Pennsylvania must meet the requirements of the Department's Quarantine Orders, regulations as set forth in Title 7 of the Pennsylvania Code and Section 9 of the Federal Code of Regulations, 9 CFR, listed below:

1. Sections 3.161 - 3.163 (relating to permit required, dipping requirements, special requirements) establish specific provisions for intrastate transportation of sheep (7 Pa.Code §§ 3.161 - 3.163).
2. Sections 3.121 - 3.124 (relating to approved interstate health certificate required, sheep for slaughter only, dipping requirements, vehicular

The Great Stoneboro Fair

sanitation) establish specific provisions for interstate transportation and importation of sheep (7 Pa.Code §§ 3.121 - 3.124).

3. Sheep must also comply with the requirements set forth in the Department's "General Quarantine Order; Scrapie" [50 Pa.B. 4751, September 19, 2020].
4. Sheep must comply with the requirements set forth in the Department's "Interstate/International Quarantine Order; Scrapie [50 Pa.B. 4754, September 19, 2020].
5. Sheep must also meet the requirements set forth in the Department's quarantine order regarding tuberculosis, "Interstate Order of Quarantine; Tuberculosis Testing Requirements for Importation of Cattle, Bison, Goats or Camelids" [49 Pa.B. 709, February 16, 2019].
6. Sheep for exhibition must comply with individual and group identification, flock origin, comingling, transportation, transfer, sale, and recordkeeping requirements established in the Code of Federal Regulations at 9 CFR 79.2 (relating to identification and records requirements for sheep and goats in interstate commerce).

K. **Swine** for exhibition in Pennsylvania must meet the requirements of the Department's Quarantine Orders and of the Department's regulations established at Title 7 of the Pennsylvania Code, and listed below:

1. Sections 3.172 - 3.180 (relating to health requirements, care and handling of breeding and feeder swine during transportation and at destination, quarantine of swine, areas considered contaminated, use of loading chutes, sanitation of contaminated facilities, records requirements, swine for exhibition) establish specific provisions for intrastate transportation of swine (7 Pa.Code §§ 3.172- 3.180).
2. Sections 3.131 - 3.139 (relating to general provisions, swine for slaughter, garbage fed swine, swine interstate commerce, brucellosis requirements, pseudorabies requirements) establish specific provisions for the interstate transportation and importation of swine (7 Pa.Code §§ 3.131-3.139).
3. Swine must comply with the requirements set forth in the Department's "Addendum to the Interstate and International Quarantine Order; Swine Exhibition Requirements" [52 Pa.B. 2363, April 23, 2022].
4. Swine must comply with the requirements set forth in the Department's "Addendum to the General Quarantine Order; Swine Exhibition Requirements" [52 Pa.B. 2363, April 23, 2022].
5. Swine must be in compliance with the requirements set forth in the Department's "General Quarantine Order; Swine Exhibition Requirements" [51 Pa.B 3861, July 17, 2021].
6. Swine must also be in compliance with the requirements set forth in the Department's "Interstate and International Quarantine Order; Swine Exhibition Requirements" [51 Pa.B., 3864, July 17, 2021].
7. Swine must be in compliance with the requirements set forth in the Department's "Interstate/International and General Quarantine Order; Importation and Intrastate Movement of Swine" [39 Pa.B. 5442, September 19, 2009].

The Great Stoneboro Fair

Biosecurity Guidelines for Exhibition Managers

2024

Many diseases of animals can be spread easily through direct contact between animals, through sharing of equipment, and through the air. People can also spread disease on their hands, clothing and footwear. According to the CDC, about 60% of known infectious diseases in people can be spread from animals, about 75% new or emerging infectious diseases in people come from animals.

There are four important goals of an effective biosecurity plan:

1. Protect animals from disease,
2. Protect exhibitors from disease, and
3. Protect the public from disease.
4. Allow the show to continue with minimal interruption due to animal disease.

Animal exhibitions/shows can lead to an increased risk of disease spread between animals, for several reasons—animals from multiple places congregate at these locations; animals are often stressed from being transported and from all the unusual sights and sounds at the show; and they may be exposed to animals with inapparent health issues.

For this reason, all show managers and exhibitors should have standard biosecurity protocols in place, to include:

Show Managers- At the Show:

Animals:

1. Make arrangements with a veterinarian in advance to oversee animal health for the event, and to be on call to respond to any concerns, including animal health emergencies.
2. Ensure the Animal Health requirements are publicized and clearly stated. Requirements should be as stringent as possible.
3. Ensure that all animals meet the requirements before entry. Require that animals arrive only during specified check-in times with appropriately trained inspectors there to check paperwork.
4. Have appropriately trained inspectors monitor the health of the animals throughout the event (this includes swine health monitors).
5. Contact the show veterinarian with any animal health concerns. The Department of Agriculture should be contacted if an inspector or veterinarian suspects a reportable

The Great Stoneboro Fair

disease. Designated caretakers should be assigned to these animals until it is determined that they may be moved back to the farm of origin.

6. Waterfowl for exhibit should be kept separate and apart from other poultry in a biosecure manner.

Animal Barns:

1. Clean and disinfect animal buildings and pens, and allow them to dry, before moving animals onto the grounds. Follow label directions and safety instructions for mixing and using disinfectants.
2. Manage the number of animals in each pen or coop to avoid overcrowding and overheating.
3. Minimize animal stress by ensuring animals are housed so that they have good ventilation and access to fresh, clean water, feed, and bedding.
4. Identify an isolation area before animals arrive, and move sick animals to this area as soon as they are identified
5. Keep dust to a minimum.
6. Maintain rodent and insect control programs in the barns which are safe for exhibitors, visitors, and exhibit animals.
7. Manage water run-off and avoid allowing standing water in the barns.

Exhibitors and General Public:

1. Encourage exhibitors to practice good biosecurity at the event and when returning home with their animals.
2. Provide every exhibitor with a show manager's cell phone number to report concerns throughout the event.
3. Maintain handwashing stations and signage (as required by the Pennsylvania Consolidated Statutes, Title 3, Chapter 25) for exhibitors and the public, and encourage frequent handwashing, especially after handling animals and before eating.
4. Discourage eating and drinking in the animal areas.
5. Discourage the general public and exhibitors from bringing any other animals with the exception of service animals into the exhibition animal areas.

Judging areas:

1. Clean and disinfect judging areas, and allow them to dry, before judging begins.
2. Remove animal manure between groups and store it properly in the designated manure area.
3. Keep dust to a minimum.
4. Manage water run-off and avoid having any standing water in the judging area. If using water to control dust, the water applicator, whether it be a water truck, sprinkler, or hose, must be properly adjusted to apply an appropriate amount of water to ensure standing water is not an issue.

The Great Stoneboro Fair

5. Set up the judging area, including the waiting area, to avoid nose-to-nose contact between animals.

Animal Weight Scales:

1. Clean and disinfect scales used for weighing market animals as needed.

Wash areas:

1. Clean and disinfect designated wash areas, and allow them to dry, before the animals arrive.
2. Maintain sufficient water drainage to avoid having standing water in the wash area.
3. Ensure that animal manure is removed promptly and stored properly in the designated manure area.

Unloading areas:

1. Clean and disinfect the docks used for unloading, and allow them to dry, before the animals arrive.
2. Maintain sufficient water drainage to avoid having standing water in the unloading areas.
3. Ensure that animal manure is removed promptly and stored properly in the designated manure area.

Trailers and Trailer Parking areas:

Ensure that animal manure and bedding which falls out of the trailers is removed promptly after unloading and is stored properly in the designated manure area..

Manure Management:

Ensure that animal manure is stored properly in the designated manure area, which is in an area not used by visitors, easily accessible to exhibitors, and in an area with no liquid run-off. Fly and rodent control should be in place.

Keeping Your Show Animals Healthy-Biosecurity Guidelines for Exhibitors—2024

A show can be stressful for your animals. Transportation, unfamiliar housing, new sources of water, new noises, being around different animals, etc. can all cause stress. Stress causes physical changes in their bodies, and their immune systems can be affected, making them more susceptible to becoming sick and spreading disease to other animals. You need to be proactive to protect your animals. The following guidelines can be used to help you do this.

BEFORE THE SHOW

Keep your animals healthy

- Have your animals checked on at least an annual basis by a veterinarian, and contact your veterinarian anytime you think an animal is acting "off". You know your animals better than anyone else does.
- Check the animal health requirements and recommendations of the show so you are prepared.
- Follow your veterinarian's recommendations for vaccinations for each animal. Vaccinate far enough in advance so your animals are protected before the show and maintain records of any vaccinations and testing done prior to the show.

Biosecurity is critical:

- Biosecurity is defined as procedures intended to protect animals or people against disease.
- If your animals are showing signs of illness, or have been exposed to sick animals, keep them home and call your veterinarian.
- If you raise multiple species of poultry, it is recommended that waterfowl are kept separate and apart from other poultry in a biosecure manner.
- Before the show, make sure the truck and trailer are visibly clean and sanitary.
- Before packing up for the show, make sure your tack box and any stall equipment has been cleaned and disinfected.
- Take only clean tack to the show.

DURING THE SHOW

- Keep your animals' stalls or pens clean and dry, and dispose of manure in the proper location.
- Monitor your animals closely for any signs of illness and report any concerns to the show manager or veterinarian.
- Keep your animals cool to avoid overheating.
- Maintain good ventilation in the stall or pen—use fans placed outside of the animals' reach if necessary and if allowed by the show management.
- Avoid nose-to-nose contact between your animals and other exhibitors' animals.
- Don't share equipment, feed or water buckets, or tack with other exhibitors.
- Don't use shared equipment in a wash area or milking area, and try to keep your animals from touching walls or tie chains that other animals have touched.
- Always keep clean, fresh water available to your animals.
- Keep dust to a minimum.
- Prevent the public and other exhibitors from touching or feeding your animals.
- Wash or sanitize your hands frequently, to protect your animals and for your own safety.
- Avoid eating or drinking in the animal area.

AFTER THE SHOW

- Isolate any animals that were at the show from the rest of your animals at home for at least 2 weeks for livestock and 3 weeks for poultry, and watch them carefully for any signs of illness.
- Care for the animals that were at the show after you care for the other animals, and always wear clean clothing and shoes or boots to care for the other animals.
- Don't share equipment between the animal groups during the isolation period.

The Great Stoneboro Fair

PDA January 2024

OWNER ENDORSED AVIAN HEALTH CERTIFICATE AND BIOSECURITY STATEMENT **2024**

Introduction: Highly pathogenic avian influenza is a fatal and contagious disease of poultry, and has led to the loss of more than 65 million birds in the US since 2022. The virus causing this disease can be spread by infected poultry, on poultry products such as feathers and eggs, on clothing and other fomites such as packing materials, and through the air. However, if all protocols for reducing the risk of spreading disease are followed, certain poultry, feathers and eggs may be exhibited, at the Department's discretion.

A completed Owner Endorsed Avian Health Certificate and Biosecurity Statement must accompany all avian species (including poultry), eggs, and feathers to a Pennsylvania exhibition. The certificate must be presented to exhibition management prior to cooping of all avian species or displaying of eggs or feathers. This form must be endorsed with the bird, egg, or feather owner's signature.

Avian. Related to birds.

Poultry. The term "poultry" includes all domesticated fowl, including chickens, turkeys, ostriches, emus, rheas, cassowaries, waterfowl, and game birds (pheasants, partridge, quail, grouse, and guineas); but excludes doves, pigeons, psittacine and passerine birds.

As established in the current *Pennsylvania Department of Agriculture Animal Health Requirements and Recommendations for Animal Exhibition, Including Commercial Exhibition*, an Owner Endorsed Avian Health Certificate and Biosecurity Statement must accompany avian species and poultry products to all animal exhibitions in the Commonwealth of Pennsylvania.

The following information is required:

1. Exhibition Information:

a. Name of exhibition: _____

b. Address of exhibition: _____

Street, Route, or Box Number

City

State

Zip

2. Owner Information:

a. Owner name: _____

b. Owner address: _____

Street, Route, or Box Number

City

State

Zip

c. Owner telephone number: (____) _____

d. Owner email address: _____

3. Requirements for Exhibition of Feathers, Eggs, and Poultry in Pennsylvania

a. Ornamental Feathers:

(i) Sourced in the United States.

Page 1 of 4

- (ii) Ornamental feathers sourced from poultry to be entered into a competition or used to produce jewelry or other items to be exhibited/sold shall be free of visible manure, litter, or other debris.
- (iii) Transport container shall have been cleaned and disinfected before being used to transport feathers to the exhibition.
- (iv) An Owner Endorsed Avian Health Certificate and Biosecurity Statement or a Certificate of Veterinary Inspection (CVI) shall accompany the feathers. If a CVI is used, endorsement of biosecurity on the Owner Endorsed Avian Health Certificate and Biosecurity Statement shall also accompany the feathers.
- (v) Ornamental feathers to be entered into a competition or used to produce jewelry or other items to be exhibited/sold shall originate from a flock which is not known to be infected with avian influenza. This requirement can be met by using one of the following methods:
 - (aa) Ornamental feathers sourced from poultry shall originate from a flock which had a negative AI test (see testing requirements for poultry below (section c) within the 14 days prior to the opening date of the exhibition. The feathers shall be accompanied by the most recent test report (copy acceptable). OR
 - (bb) Ornamental feathers sourced from poultry to be entered into a competition or used to produce jewelry or other items to be exhibited/sold shall be clean, and held in a clean area separate from poultry or other poultry products for at least 120 days at a minimum of 68 degrees Fahrenheit before exhibition. The date the feathers were moved to a holding area, along with the holding temperature, shall be included on the Owner Endorsed Avian Health Certificate and Biosecurity Statement.

b. Unfertilized Poultry Eggs for Exhibition:

- (i) Eggs shall be washed and sanitized in a 100-200 ppm chlorine solution or other EPA-approved disinfectant which is effective in destroying influenza virus, and dried before being placed in a carton.
- (ii) Eggs shall be packaged in a new cardboard or Styrofoam carton or in a plastic carton which was cleaned, disinfected, and dried, for entry into an event.
- (iii) An Owner Endorsed Avian Health Certificate and Biosecurity Statement or a Certificate of Veterinary Inspection (CVI) shall accompany the eggs. If a CVI is used, endorsement of biosecurity on the Owner Endorsed Avian Health Certificate and Biosecurity Statement shall also accompany the eggs.
- (iv) The source flock shall have had a negative AI test (see testing requirements for poultry below (section c) within the 14 days prior to the opening date of the exhibition.

c. Poultry for Exhibition:

- (i) Poultry may be exhibited only if they will be moved immediately after judging directly to a facility for slaughter from the show grounds. All poultry exhibited in Pennsylvania at Department sponsored or funded exhibitions shall move as all-in and all-out directly to a Department or United States Department of Agriculture (USDA) licensed slaughter facility following the animal exhibition and may not be diverted to premises other than a recognized slaughter establishment.
- (ii) Arrival, exhibition and departure of the poultry shall occur within a 72-hour window. The 72 hours begin when the first poultry arrive on the show grounds, whether unloaded or not, and ends when the last poultry physically leave the premises in a vehicle.
- (iii) All poultry entering a show shall be identified with official Department leg bands.
- (iv) An Owner Endorsed Avian Health Certificate and Biosecurity Statement or a Certificate of Veterinary Inspection (CVI) shall accompany the poultry. If a CVI is used, endorsement of biosecurity on the Owner Endorsed Avian Health Certificate and Biosecurity Statement shall also accompany the poultry.

The Great Stoneboro Fair

PDA January 2024

- (v) All poultry on the show grounds shall be monitored for signs of illness, and any signs of illness shall be reported to the Department immediately (717-772-2852).
- (vi) All poultry on the show grounds shall be displayed behind barriers such as ropes to prevent public access to the poultry, with signage to prevent the public from crossing the barrier.
- (vii) Conveyances shall be cleaned and disinfected before loading to transport poultry to the show, and after returning to the premises of origin.
- (viii) **Avian Influenza Testing and Verification:**
 - (aa) All samples shall be collected by a Certified Poultry Technician or a Category II Accredited Veterinarian and shall be tested in a National Animal Health Laboratory Network (NAHLN) laboratory.
 - (bb) All poultry for exhibition shall originate from a flock in which a random, representative sample of a minimum of 30 birds, 3 weeks of age or older, were tested for avian influenza within the 14 days prior to opening date of the exhibition.
 - (cc) For waterfowl, cloacal swab samples shall be collected for testing. Swabs from geese and ducks may not be combined in the same tube for testing.
 - (dd) For chickens, turkeys, game birds, and ratites, blood samples (AGID testing) or tracheal or oropharyngeal swab samples (PCR testing) are acceptable samples. Samples from more than one species may not be combined in the same tube for testing.
 - (ee) The poultry shall be accompanied by the most recent test report (copy acceptable). Test results shall be negative.
 - (ff) If there are fewer than 30 birds in the flock, test all birds of age.
 - (gg) Untested samples shall not be comingled with or added to the tested flock after negative samples have been collected and before the show.

4. Verification of avian health status: All poultry for exhibition and all source flocks for eggs and feathers being exhibited or displayed are free from evidence of infectious and contagious diseases.

5. Verification of biosecurity: Biosecurity measures for all feathers, eggs, and poultry being exhibited or displayed include:

- (i) A biosecurity plan is followed on the premises where the source flock is located, to include at minimum:
 - (aa) Visitors to bird areas are restricted.
 - (bb) Anyone visiting the poultry area should have clean clothing and should have used hand sanitizer or washed their hands before handling poultry or poultry products.
 - (cc) Designated footwear or footwear that has been cleaned and disinfected is worn in the poultry area. A clear line of separation exists at the entrance to the poultry area.
- (ii) All feathers and eggs are maintained apart from the poultry flock prior to entry into the exhibition.
- (iii) All conveyances, including transport vehicles, coops, crates, boxes, and other containers used to transport animals or products to the show are cleaned to be free of visible manure, litter, or other debris.
- (iv) All coops, crates, boxes, and other containers used to transport animals or products to the show shall be disinfected with a product effective against the avian influenza virus and allowed to dry before use.
- (v) All exhibitors should follow the biosecurity guidelines: *Keeping Your Show Animals Healthy-Guidelines for Exhibitors* (11/28/23).

6. Owner Endorsement:

I certify that the above information represents a true and accurate statement regarding my bird(s), eggs, or feathers, and their home flock(s). I further attest and affirm that a "veterinarian client patient relationship" – as that phrase is defined in the Animal Exhibition Sanitation Law found at 3

The Great Stoneboro Fair

PDA January 2024

Pa.C.S.A. § 2501 *et seq.* and any amendments thereto – "exists with regard to any avian species and products which I will be exhibiting".

7. Owner Printed Name: _____

8. Owner Signature: _____ Date: _____

To report illness or mortality in your flock, call the Pennsylvania Department of Agriculture at 717-772-2852. Forms are available on the Department website at www.agriculture.pa.gov.

The Great Stoneboro Fair

Animal Owner or Caretaker's Verification of Veterinarian Client Patient Relationship

I, the undersigned, hereby verify the following:

1. I am the owner or caretaker of the animal(s) listed. Use additional sheets as necessary.

Official Animal ID/Other ID (list all IDs, including name*)	Breed	Sex	Age	Species	Vaccines/Tests (include name of test or product, date, results, etc.)

*If the animal has no official ID, please include a description, including color and all markings.

2. I have an established, ongoing "veterinarian-client-patient relationship" for the animal(s) described in the preceding paragraph with

_____ (print veterinarian's name), a licensed practitioner of veterinary medicine having the following business address:

3. I understand this ongoing "veterinarian-client-patient relationship" to be a relationship in which the veterinarian named in the preceding paragraph has assumed the responsibility for making veterinary medical judgments regarding the health of the animal(s) described above and the need for veterinary medical treatment of said animal(s), and in which I, as owner and/or caretaker of the animal(s), have agreed to follow the instructions of the veterinarian in relation to animal diseases.

4. I attest and affirm that a "veterinarian client patient relationship," as that phrase is defined in the Veterinary Medical Practice Act, which is set forth below, exists with regards to the animals identified above in this form and for all animals I will be exhibiting.

I verify the foregoing to be accurate. I make the foregoing statement subject to the penalties of 18 Pa.C.S.A. § 4904 (relating to unsworn falsification to authorities). In witness of this, I have signed and dated this verification below. If the owner/caretaker is under 18 years of age, the signature of a parent/guardian is required.

Printed Name of Owner/Caretaker

Signature of Owner/Caretaker

Date

The Great Stoneboro Fair

Address of Owner/Caretaker

Phone number of Owner/Caretaker

If the Owner/Caretaker is under 18 years of age:

Printed Name of Parent/Guardian

Signature of Parent/Guardian

Date

Address of Parent/Guardian

Phone number of Parent/Guardian

Veterinarian verification:

I, the undersigned, hereby verify that I have a **Veterinarian-client-patient-relationship** as defined below with the animal(s) and owner/caretaker identified on this form.

Veterinarian-client-patient-relationship. As defined in the Pennsylvania Veterinary Medicine Practice Act (act of December 27, 1974, P.L. 995, No. 326, § 3, as amended)(3 P.S. § 485.3), "means a relationship satisfying all of the following conditions: (i) the veterinarian has assumed the responsibility for making veterinary medical judgments regarding the health of an animal and the need for veterinary medical treatment, and the client, owner or caretaker of the animal has agreed to follow the instructions of the veterinarian; (ii) the veterinarian has sufficient knowledge of the animal to initiate at least a general, preliminary or tentative diagnosis of the medical condition of the animal; (iii) the veterinarian is acquainted with the keeping and care of the animal by virtue of an examination of the animal or medically appropriate and timely visits to the premises where the animal is kept; (iv) the veterinarian is available for consultation in cases of adverse reactions to or failure of the regimen of therapy; (v) the veterinarian maintains records on the animal examined in accordance with regulations established by the board.

Printed Name of Veterinarian

Signature of Veterinarian

Date

Phone number of Veterinarian

Practice Name

License number

Page 2 of 2

Thank You to the Stoneboro Fair Advertisers

The Great Stoneboro Fair

Linda Butler, Entry Secretary (724) 699-3278
Lou Ann Iskat, Entry Secretary (724) 699-7239
P.O. Box 215, Stoneboro, PA 16153
Fax (724) 376-7457

ENTRY BLANK

Make entries Early by Mail or Fax - Entry Deadline Aug. 7, 2024
Entry No. _____ (Office Use Only)

DATE _____ 20_____

DEPARTMENT _____

Dept. No.	Sec.	Class	Item

	<p>Look! Free T-shirt for YOUTH Exhibitors while supplies last! Register early!</p>
---	--

The Great Stoneboro Fair

Dept. No.	Sec.	Class	Item



Entry Day for Rabbits & Fine Arts
ONLY will be Tuesday, August 27th
 from 8 AM - 8 PM.
 Depts. 9, 17, 18, 19 & 11 (Sections 2-6)

Premium checks must be picked up Labor Day from 6 PM - 10 PM at the Entry Office, or you can supply a self-addressed stamped envelope with your entry.

NAME _____
ADDRESS _____
CITY _____ **STATE** _____ **ZIP** _____
COUNTY _____
PHONE NO. _____

Waiver: In consideration of the acceptance of this entry, I waive for myself, my heirs, and assigns, all claims for any loss, personal injury, or damages which I might have against The Great Stoneboro Fair or its Stockholders as a result of any and all injuries which might be received during the Great Stoneboro Fair.

SIGNATURE REQUIRED _____

Parent must sign if Exhibitor is under 18 years.

The Great Stoneboro Fair

Linda Butler, Entry Secretary (724) 699-3278
Lou Ann Iskat, Entry Secretary (724) 699-7239
P.O. Box 215, Stoneboro, PA 16153
Fax (724) 376-7457

Animal Entries Only

ENTRY BLANK

Make entries Early by Mail or Fax - Entry Deadline Aug. 7, 2024

Entry No. _____ (Office Use Only)

ENTRY FEE FOR ANIMALS ONLY

DATE _____ 20 _____

DEPARTMENT

Dept. No.	Sec.	Class	Ear Tag Or Tattoo#	Animal - -as in List, Breed, etc.	Entry Fee



**Look! Free T-shirt for
YOUTH Exhibitors
while supplies last!
Register early!**

The Great Stoneboro Fair

Dept. No.	Sec.	Class	Ear Tag Or Tattoo#	Animal - -as in List, Breed, etc.	Entry Fee
				TOTAL \$	

“I attest and affirm that a “veterinarian consultation relationship” – as that phrase is defined in the Animal Exhibition Sanitation Law found at 3 Pa.C.S.A. § 2501 et seq. and any amendments thereto – “exists with regard to any animals I will be exhibiting.”

Consulting Veterinarian Name: _____
 Phone: _____

Premium checks must be picked up Labor Day from 6 PM - 10 PM at the Entry Office, or you can supply a self-addressed stamped envelope with your entry.

Please show total of animals entered _____ Pens or Stalls _____

NAME _____

ADDRESS _____

CITY _____ **STATE** _____ **ZIP** _____

COUNTY _____

PHONE NO. _____

Waiver: In consideration of the acceptance of this entry, I waive for myself, my heirs, and assigns, all claims for any loss, personal injury, or damages which I might have against The Great Stoneboro Fair or its Stockholders as a result of any and all injuries which might be received during the Great Stoneboro Fair.

SIGNATURE REQUIRED _____

Parent must sign if Exhibitor is under 18 years.

REQUEST FOR CAMPING SPACE

TYPE OF CAMPER

Tent _____

Travel Trailer _____

Motor Home _____

Camping Fee – (campers) \$75.00 _____

Tents \$40.00 _____

Number of Air Conditioning Units @ \$12.00 each _____

Total Cost - Camping Plus Air Conditioning _____

Campers must have permit before entering camping area.

Window Permit will be issued and is required to be displayed in camper window.

No campers admitted before 10:00 AM on Sunday, August 25, 2024. Campers not complying will be removed.

Campers will park where designated.

All campers and camping equipment must be removed within 10 days after the close of Fair.

***No Campfires or open fires of any kind in campground**

ANIMAL EXHIBITORS & CONCESSIONAIRES ONLY

Name (Print) _____

Address _____

License No. _____ Phone No. _____

Waiver: In consideration of the acceptance of this entry, I waive for myself, my heirs, and assigns, all claims for any loss, personal injury, or damages which I might have against The Great Stoneboro Fair or its Stockholders as a result of any and all injuries which might be received during the Great Stoneboro Fair.

Signature required: _____

*Come
Celebrate the
156th
Great
Stoneboro
Fair
this Year!*

The Great Stoneboro Fair

Linda Butler, Entry Secretary, (724) 699-3278

Lou Ann Iskat, Entry Secretary, (724) 699-7239

P.O. Box 215, Stoneboro, PA 16153

Fax (724) 376-7457

4-H Entries Only

ENTRY BLANK

Make entries Early by Mail or Fax - Entry Deadline Aug. 7, 2024

Entry No. _____ (Office Use Only)

NO ENTRY FEE FOR 4-H ANIMALS

DATE _____ 20 _____

DEPARTMENT

Dept. No.	Sec.	Class	Ear Tag Or Tattoo#	Animal - -as in List, Breed, etc.



Register Early!

Look! Free T-shirt for YOUTH Exhibitors while supplies last! Register early!

The Great Stoneboro Fair

Dept. No.	Sec.	Class	Ear Tag Or Tattoo#	Animal - -as in List, Breed, etc.

“I attest and affirm that a “veterinarian consultation relationship” – as that phrase is defined in the Animal Exhibition Sanitation Law found at 3 Pa.C.S.A. § 2501 et seq. and any amendments thereto – “exists with regard to any animals I will be exhibiting.”

Consulting Veterinarian Name: _____

Phone: _____

Premium checks must be picked up Labor Day from 6 PM - 10 PM at the Entry Office, or you can supply a self-addressed stamped envelope with your entry.

Please show total of animals entered _____ Pens or Stalls _____

NAME _____

ADDRESS _____

CITY _____ **STATE** _____ **ZIP** _____

COUNTY _____

PHONE NO. _____

Waiver: In consideration of the acceptance of this entry, I waive for myself, my heirs, and assigns, all claims for any loss, personal injury, or damages which I might have against The Great Stoneboro Fair or its Stockholders as a result of any and all injuries which might be received during the Great Stoneboro Fair.

SIGNATURE REQUIRED _____

Parent must sign if Exhibitor is under 18 years.



2024 Youth Fair Poster Contest

Theme: Connecting Our Communities

The Pennsylvania Department of Agriculture will once again conduct a statewide poster contest at the agricultural fairs. Participating fairs will hold their own contest and submit one poster from each age group to the state level for additional judging and cash prizes. **Entries must be received by or postmarked on November 1, 2024.**

1. Only one poster may be submitted per exhibitor, per age group. There will be three state competitions: ages 8-11, 12-14, and 15-18. Exhibitors must be in one of these age groups as of June 1 of the current fair season to qualify.
2. The poster size must be either 14 x 22 inches or 14 ½ x 22 inches. Other sizes will not be accepted for judging at the state level.

This year's theme is "**Connecting Our Communities**" Contestants will be asked to submit artwork that showcases the pride and hard work of farmers from across the state, connecting people from all walks of life for a celebration of the importance of agriculture in our communities. Exhibitors using other themes will be disqualified at the state level.

3. **The fair secretary or contest coordinator is responsible for submitting the poster and completing the entry form for each poster with each age group to the Fair Office.** Please be sure to provide all the information requested on the entry form; incomplete forms will be returned. **The poster and entry form can be given to the Fair Administrator at the PSACF fall zone meetings or mailed to the Fair Fund Office:**

**Tracy Barone, Fair Fund Administrator
PA Department of Agriculture
2301 North Cameron Street, Room 310
Harrisburg, PA 17110**

The poster contest entry form can be obtained online on the Department's website.

4. Posters must be packaged flat. Posters rolled or folded will be ineligible for judging. **Please, do not** mail the posters to the PA Farm Show Complex.
5. Posters must be received by, or post marked on **November 1, 2024**.
6. Posters will be evaluated on use of the theme, visual appearance and creativity in relation to the exhibitor's age.
7. Premium checks for:

1 st place	\$100
2 nd place	\$75
3 rd place	\$50

These checks will be presented by the Pennsylvania Department of Agriculture to the top three individuals. Winners will be notified in advance and invited to attend an awards presentation. **Participants are required to provide their social security numbers for award disbursements from the PA Department of Agriculture.**

All posters will become the property of the Pennsylvania Department of Agriculture for possible future promotional activities for the Pennsylvania Farm Show and Pennsylvania State Association of County Fairs. Any duplication of posters from previous years will be disqualified. Posters will not be returned via mail. Contestants may arrange to have their entries returned following the PA Farm Show through their individual fairs; however, the posters must be picked up in person at the PSACF Convention or Spring Zone Meetings.

The Great Stoneboro Fair



Due November 1st!

POSTER CONTEST ENTRY FORM FOR PENNSYLVANIA FARM SHOW

Connecting Our Communities - 2024 Fair Season Youth Poster Contest

Sponsored by the Pennsylvania Department of Agriculture

PLEASE PRINT IN INK

DATE _____

FAIR NAME _____

COUNTY _____

EXHIBITOR'S NAME _____

EXHIBITOR'S ADDRESS _____

CITY, STATE, ZIP _____

EXHIBITOR'S TELEPHONE NUMBER _____

E-MAIL _____

EXHIBITOR'S DATE OF BIRTH (REQUIRED) _____

This is to certify that _____

was the winner in our fair's "Connecting Our Communities" Poster Contest.

AGE GROUP (circle one)

8-11

12-14

15-18

(Signature of Fair Secretary or Contest Coordinator)

Print Name:

Phone Number:

Exhibitors must be in one of the proper age groups as of June 1 of the current fair season to qualify. This form must accompany all winning posters. Please be sure to provide all the information requested (above).

Entries can be forwarded any time after your fair is over, but must be postmarked by or received no later than **November 1, 2024** to:

**Tracy Barone, Fair Fund Administrator
Pennsylvania Department of Agriculture
2301 North Cameron Street, Room 310
Harrisburg, PA 17110**

The winning entries will be displayed during the 2025 Pennsylvania Farm Show. All posters will become the property of the Pennsylvania Department of Agriculture for possible future promotional activities for the Pennsylvania Farm Show and Pennsylvania State Association of County Fairs. Posters will not be returned.

****See criteria for additional information. ****